LOCAL PATH DESIGN GUIDE

REV 1.2





Authors: Resilio Studio and MRCagney

Clients: Auckland Transport and
Auckland Council



CONTENTS

PART 1_ OVERVIEW

1.0	INTRODUCTION	5
1.1	WHAT IS A LOCAL PATH?	7
1.2	DESIGN PRINCIPLES	12
1.3	PERFORMANCE STANDARDS	14

PART 2_ NETWORK PLANNING

2.0	INTRODUCTION	23
2.1	LOCAL PATH TYPES	24
2.2	NETWORK PLANNING	25

PART 3_ LOCAL PATH TOOL KIT

3.0	INTRODUCTION	35
3.1	TOOLS FOR PLACEMAKING	36
3.2	TOOLS FOR PARKS	52
3.3	TOOLS TO REDUCE TRAFFIC VOLUME	78
3.4	TOOLS TO REDUCE TRAFFIC SPEED	88
3.5	TOOLS FOR CROSSING THE STREET	102
3.6	SIGNAGE & PATH MARKINGS	116

PART 4_ APPENDIX

4.0	COST GUIDE	125
-----	------------	-----

PART ONE

OVERVIEW

1.0

INTRODUCTION

Building a connected Auckland is an essential part of creating the world's most liveable city, and an Auckland Paths network is creating walking and cycling connections across the region.

Central to the concept of Auckland Paths is that they are designed to provide 'active transport' options, appealing especially to those in the community that may not be comfortable cycling or walking on streets where cars are prioritised.

Local Paths

Local Paths consist of quiet streets with slow-moving vehicles plus routes through parks. These routes safely connect communities to local destinations such as schools, town centres, public transport stops, and recreation spaces, and extend accessibility to the wider cycle network.

Walking or cycling for short local trips instead of driving can reduce the stress on the transportation network, support local businesses, provide wider health benefits and help to create more connected communities.

Equally as important, Local Paths provide a range of opportunities to enhance Auckland's natural environment and for local communities to reflect local identity, pride and connection to place. A Local Path will generally include most Local Board Greenway plan routes.

Express Paths consist of designated cycleways, which, by contrast, provide safe cycle facilities along busy streets, arterials, and transportation corridors, and in some cases shared routes with pedestrians. These routes tend to be focused on longer distance (commuter) travel between major destinations such as regional-scale employment centres or public transport interchanges.

This Guide

The Local Paths Design Guide is organised into three parts. It defines what a Local Path is and what it isn't, and illustrates how they connect to Auckland's wider transport network.

Part One provides key performance standards and design principles based on international best practice that can be used to both develop and evaluate future Path projects.

Part Two outlines a step-by-step guide describing how the Paths network could be designed and planned.

Part Three describes a wide range of tools from community engagement and the application of physical infrastructure for streets. 'Placemaking' tools outline how Te Aranga Design Principles, community engagement strategies and environmental benefits can be incorporated in the design process and implementation of a Local Paths project. Tools for Parks outlines strategies and tools for implementing Local Paths through parks and open spaces.

Finally, a range of physical infrastructure interventions for designing and retrofitting streets are outlined. These features are organised as tools for reducing traffic volumes, tools for reducing traffic speeds, tools for crossing the street, and signage and street/path markings.

1.1

WHAT IS A LOCAL PATH?

Local Paths use a combination of design treatments to reduce both the number and the speed of cars, provide design priority for people riding bicycles, and also improve the conditions for walking.

Providing welcoming, safe and pleasant streets encourages more people to walk and cycle for local trips. Local Paths benefit the wider bicycle and pedestrian network by connecting up to longer distance routes such as Express Paths, typically located along arterial roads. Local Paths can also be created by connecting streets to park routes and trails. The following pages (pages 10-11) show how Local Paths fit into related transportation and recreational networks.

Reducing the number and speed of vehicles is critical to the design of Local Paths. Streets with few cars and slow speeds make for safer, more comfortable conditions for cycling and walking and a pleasant experience. Local Paths also include safe crossings of major streets and “wayfinding” to direct users along the route and to their destinations.

The Auckland Paths network is comprised of the following:

Express Path

Express Paths are cross-city connections that provide for both walking and cycling separated from vehicles. They provide for faster movement than Local Paths and create links to regional and local centres.

Local Path

Local Paths are both on and off-street, and are designed to create safe and pleasant neighbourhoods that encourage walking and cycling for local trips. The naming of these paths provide the opportunity to reflect local places, names, land marks and connection to mana whenua.

An on-street Local Path has pedestrians accommodated on footpaths with streets that are safe enough to cycle on without the need for separated cycle lanes. Traffic calming tools, pavement markings and signage are used to improve safety for all street users.

Off-road Local Paths run through parks and open spaces and accommodate both cyclists and pedestrians. Together with on-street Paths, they are designed to create linkages to local centres, parks, schools and transport links including Express Paths. A Local Path will generally include most Local Board Greenway plan routes.

Trail

A trail is distinct from a Local Path in that it is found in rural or bush settings and is primarily for recreation. Many trails will connect to Local or Express Paths, but may also allow for horse-riding alongside walking and cycling. A trail can also be a bush walk, which due to topography would not be shared by cyclists. Trails are not generally intended to form a connection between destinations, and often run in loops.

Footpath

A standard pedestrian-only path along most streets, which is not accessible for cyclists.



ital
Bowl

nutritious
sugar-free
breakfast.

Positioning Local Paths in Auckland's Walking and Cycling Network



Express Path

Express Paths are major cycleways on busy streets or off-road paths. They connect people to major centres and form the base structure of the cycleway network.

- Vehicle Volume (ADT)**_ 1,500 +
- Vehicle Speed (km/h)**_ 40 - 60
- Arterial Road Crossings**_ 50 - 100 per hour
- Accessibility + Safety**_ Ministry of Justice 7 Qualities of Safe Spaces
- Green Infrastructure**_ Impervious surface <90% / Tree canopy coverage greater than 30 - 40%

Local Path - Street

Local Paths are both on and off-street, and are designed to create safe and pleasant neighbourhoods that encourage walking and cycling for local trips.

An on-street Local Path has pedestrians accommodated on footpaths with streets that are safe enough to cycle on without the need for separated cycle lanes. Traffic calming tools, pavement markings and signage are used to improve safety for all street users.

- Vehicle Volume (ADT)**_ 1,000 ideal, 2,000 max
- Vehicle Speed (km/h)**_ 30
- Arterial Road Crossings**_ 50 - 100 per hour
- Accessibility + Safety**_ Ministry of Justice 7 Qualities of Safe Spaces
- Green Infrastructure**_ Impervious surface 70-90% / Tree canopy coverage greater than 30 - 40%



1 Sandringham, Auckland



2 Beach Road Cycleway



3 Grafton Gully Cycleway



4 Mount Roskill War Memorial Reserve



5 Mahurangi East Track



6 Henderson Creek / Opanuku Stream



Local Path - Open Space

Local Paths are both on and off-street, and are designed to create safe and pleasant neighbourhoods that encourage walking and cycling for local trips.

Off-road Local Paths run through parks and open spaces and accommodate both cyclists and pedestrians. Together with on-street Paths, they are designed to create linkages to local centres, parks, schools and transport links including Express Paths.

Vehicle Volume (ADT)_ N/A

Vehicle Speed (km/h)_ N/A

Arterial Road Crossings_ N/A

Accessibility + Safety_ 20 km/h design speed / 20 metre sight lines and stopping distance

Green Infrastructure_ Tree Park: Continuous canopy with grass and assorted low level planting



Trail

A trail is distinct from a Local Path in that it is found in rural or bush settings and is primarily for recreation. Many trails will connect to Local or Express Paths, but may also allow for horse-riding alongside walking and cycling. A trail can also be a bush walk, which due to topography would not be shared by cyclists. Trails are not generally intended to form a connection between destinations, and often run in loops.

Vehicle Volume (ADT)_ N/A

Vehicle Speed (km/h)_ N/A

Arterial Road Crossings_ N/A

Accessibility + Safety_ 20 km/h design speed / 20 metre sight lines and stopping distance

Green Infrastructure_ Park land / water systems / self regenerating forest

1.2

DESIGN PRINCIPLES

Primarily, Local Paths must meet the needs of all people walking and cycling. The design framework is based on the following principles: they must be safe, connected, accessible, comfortable and enabling.

Safe

Safety and a stress-free environment are core tenets of achieving a successful Local Path. Conflict points such as high vehicle numbers and high speeds should be minimised by providing a consistent level of experience across the Paths network. Crime prevention and enhanced social safety are also key outcomes of well-designed Local Paths.

Connected

Local Paths should connect destinations such as residential neighbourhoods, schools and universities, town centres, transit stations, and bicycle facilities. They should seamlessly connect to the wider transport network including Express Paths. Additionally, these connections should be designed to be easily navigated. Where intuitive design is unachievable, clear and consistent way finding signage should be employed.

Accessible & Comfortable

Paths infrastructure should be accessible for all users, including children and people with disabilities. Considerations include ample width, gentle gradients, smooth transition in surfaces, and avoidance of high volumes of traffic that create fumes and noise.

Enabling

Iwi, local community and stakeholders should be engaged early in the process to incorporate Te Aranga principles and community driven initiatives. Local Paths should integrate with the existing streetscape and celebrate Auckland's unique character by responding to and incorporating elements of the surrounding natural and built environment, heritage and culture. Opportunities to include ecological function through planting, water sensitive design, and low energy/low toxicity materials should be integral to each Local Path design.

1.3

PERFORMANCE STANDARDS

In addition to the design principles, the following performance standards provide quantitative and measurable benchmarks to guide Paths design:

- Vehicle Volumes
- Vehicle Speeds
- Bicycle Speeds
- Arterial Road Crossings
- Accessibility & Safety
- Green Infrastructure



Vehicle Volumes

Local Paths should be designed, built and maintained for a maximum average of 2,000 vehicles a day.

A higher number of vehicles results in vehicles passing people on bikes more often and adds challenges to street crossings. This exposure to traffic increases the risk of collision and creates a higher stress environment for people walking and cycling while decreasing the likelihood that neighbourhood streets will be used by risk intolerant users.

As shown on the facing page (right), a person cycling on a 30kph street with 3,000 cars per hour could be expected to be passed an average of 23 times in 10 minutes. For streets with 1,500 cars per hour a person cycling would only be passed seven times.

Local Paths should be designed for cyclists and vehicles to share the street. Depending on the street profile, motorists will be required to remain behind a cyclist if there is oncoming traffic.

Minimising traffic intensity and the corresponding exposure of cars to people on bikes is critical to designing safe and attractive Local Paths. The following performance standard is recommended:

Ideal: 1,000 Average Daily Traffic (ADT) or less
Acceptable: 2,000 ADT maximum

In some cases the ADT does not adequately represent the vehicle traffic during peak travel periods, for example during school start times. In these cases an alternative metric of a maximum of 75 vehicles per direction over the peak one-hour period should be used.

Effects of vehicle volumes on the number of times a person cycling will be passed by a car going the same direction during a 10 minute trip

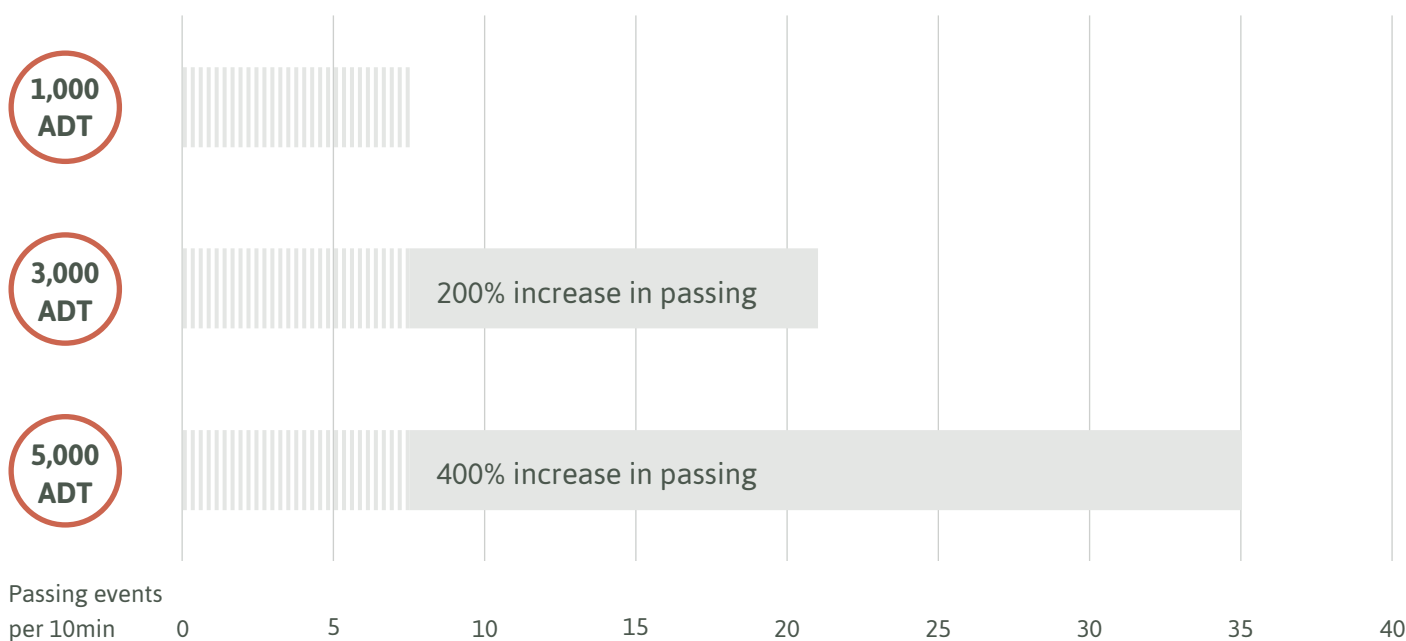

Values shown assume a 30 km/h posted speed. Local street peak hour is 15 percent of ADT. 70 percent of peak hour traffic is in the peak direction. Cars are evenly spaced along the street; no platooning. 10-minute trip calculated during peak hours. Cars are travelling the posted speed limit (speed management techniques may be necessary). Note: Cars may pass people cycling more or less frequently depending on how well these assumptions reflect reality.



Vehicle Speeds

Local Paths should be designed, built and maintained for a vehicle speed of 30kph at most (85th percentile speed).

Higher traffic speeds increase the severity of traffic crashes and increase the stopping distance of vehicles (as shown below). Reducing traffic speed results in safer and more pleasant streets. Slow streets are critical for Local Paths where sharing the roadway between cars and people on bikes is expected.

Posted speed limits are an unreliable method for determining traffic speeds. Actual vehicle speeds should be surveyed to determine the 85th percentile speed. Physical interventions will likely need to be implemented to effectively and reliably reduce speed.

Effects of Vehicle Speed on Braking Distance and Fatality Rate in Vehicle-Pedestrian Collisions

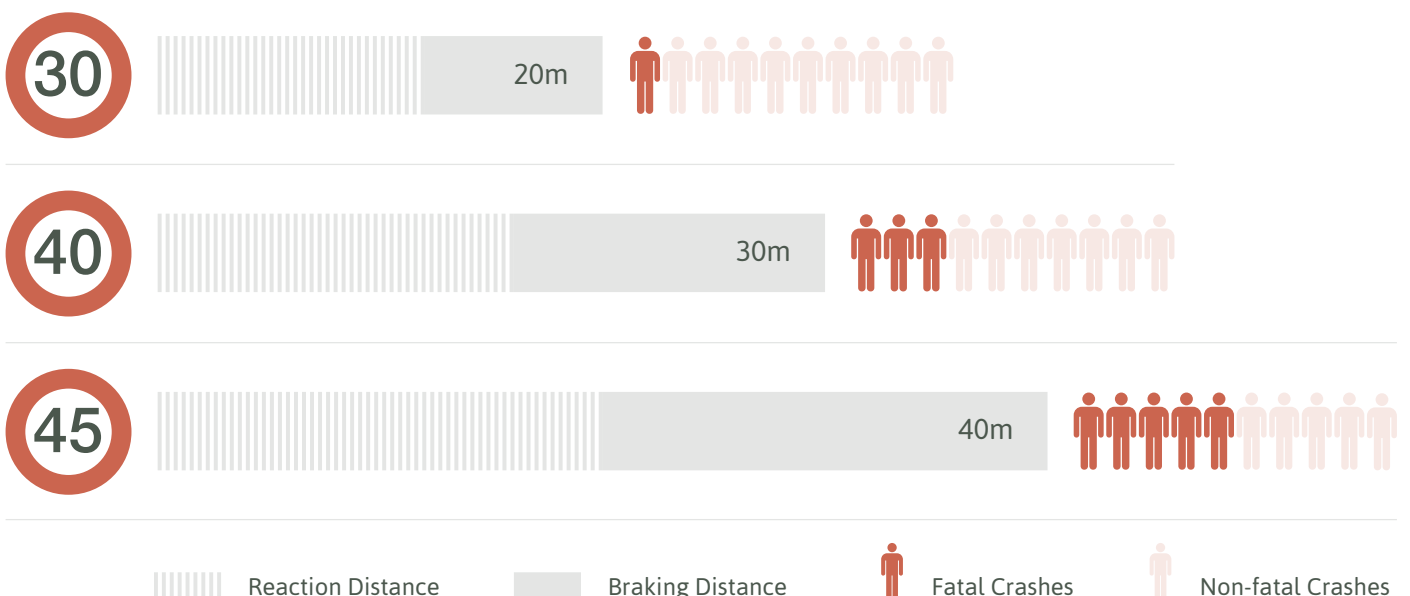



Bicycle Speeds

The maximum design speed for cyclists on Local Paths in parks and open spaces is 20km/h.

The primary challenges for creating safe and accessible on-street Local Paths is to reduce and slow vehicle traffic, when the Path is running through a park or open space and no vehicles are present, the challenge is to slow cyclists.

Safe Stopping Distances for Cyclists

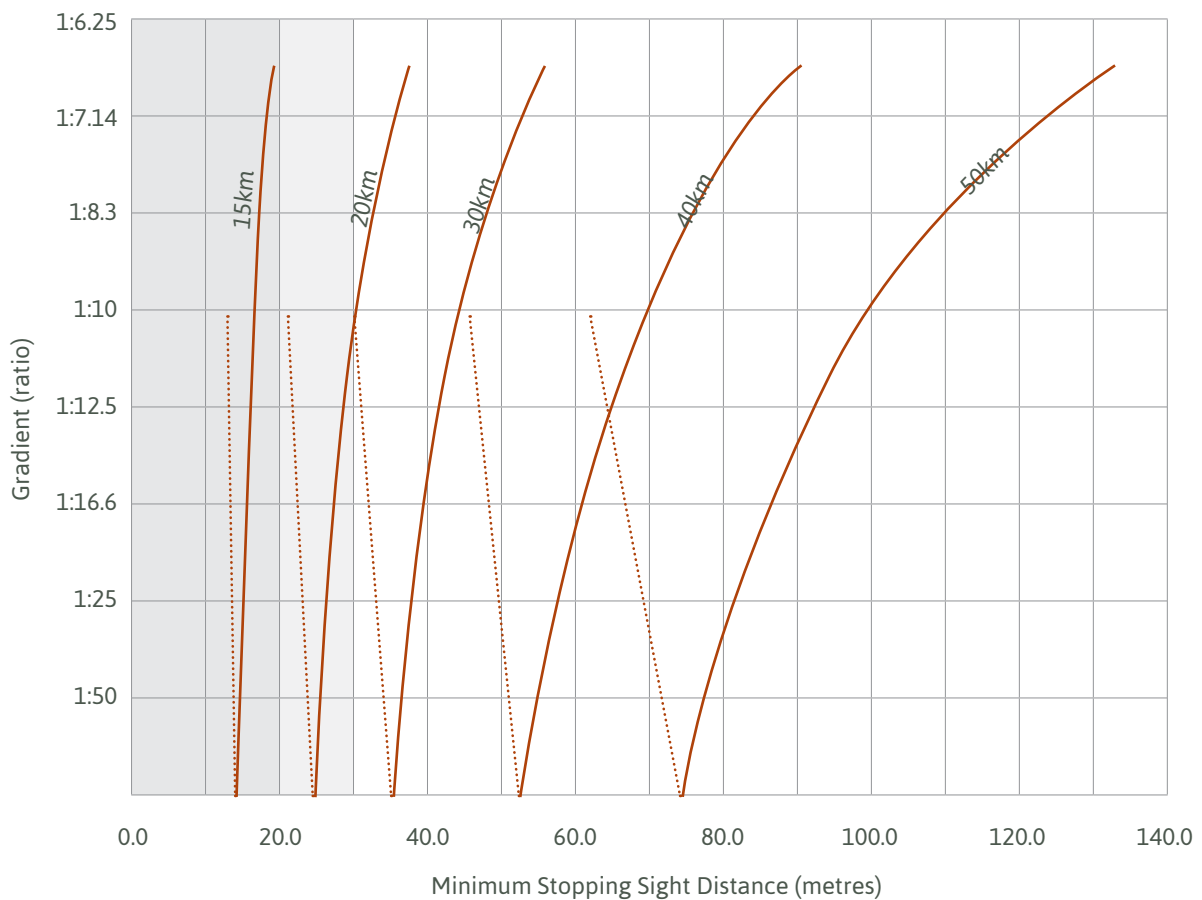

- Preferred stopping distance
- Acceptable stopping distance
- Downhill
- Uphill

Source: AASHTO (1991)

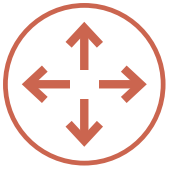

Arterial Road Crossings

At intersections with arterial or collector roads, Local Paths should be designed, built and maintained to provide a minimum of 50 crossing opportunities per hour.

Because most Local Paths will at some point link up to or cross a major street, it is important to include the requirements for these road crossings in this design guide. To ensure people can safely cross arterial roads without too much delay, these crossings should be easy and comfortable. A minimum target of 50 crossing opportunities (either signaled or unsignaled) per hour is required, but the preferred number is 100 crossing opportunities per hour.



Accessibility & Safety

Local Paths should be accessible and safe for people of all ages and abilities.

Local Paths should be designed for the most vulnerable users. In most cases this will be the young, the elderly and people with physical disabilities. In particular they should be consistent with the principles of universal design and usable by all people, to the greatest extent possible, without the need for adaptation or specialized design. Where possible, Local Paths should also be consistent with The Ministry of Justice's Seven Qualities of Safer Spaces: access, surveillance and sightlines, clear and logical layout, a mix of activity, a sense of ownership, high quality environments and active security measures.

Local Paths should be wide and unimpeded to allow for easy walking and cycling and should have gentle gradients made of appropriately textured materials with smooth transitions between surfaces. Local Paths must maintain clear sight lines around corners and over the crests of hills to ensure that sufficient distances are maintained to enable evasive action if required. In situations where it is not possible to allow for surveillance and a mix of activity such as through a park or open space, consideration should be given to increasing the visual permeability of fences enclosing the park or open space.

The Ministry of Justice 7 Qualities of Safer Places

Access: Safe movement and connections

Surveillance and sight lines: See and be seen

Layout: Clear and logical orientation

Activity mix: Eyes on the street

Sense of ownership: Showing a space is cared for

Quality environments: Well designed, managed and maintained environments

Physical protection: Using active security measures



Green Infrastructure

Whether through a park or along a street, a Local Path should be 'leafy and green' in character and contribute positively toward the ecological function of the site.

Character and Amenity

The quantity and quality of plants, trees and groundcovers either along a street or in a park contributes significantly to the character and amenity of a Local Path. Ideally, an on-street Local Path would include regularly spaced, large street trees that define and enclose the streetscape, with a variety of understory shrubs and groundcovers that are integrated into a water sensitive urban design strategy. In some cases, amenity and character can be borrowed from adjacent properties.

Ecological Function

The same green elements that characterise a Local Path should also contribute to the ecological function of the site. The potential ecological functions of a Local Path include sequestering carbon, regulating local climatic conditions by reducing the urban heat island effect, stabilizing soils, contributing towards biodiversity and wildlife habitat, filtering of water and reducing stormwater runoff and potentially even producing fruits, nuts and vegetables for local community and Pa harakeke for weaving.

Minimum Green Threshold

The diagram to the right provides guidance on the minimum and preferred thresholds of green required for a Local Path either on-street or through a park. In some cases the street will already have enough 'green' to meet the criteria . If not, enhancement planting and potentially infrastructure works will be necessary to achieve the minimum green threshold. In most cases, parks and open spaces offer the necessary preconditions for a Local Path to be implemented directly into the space, in some cases additional planting may be required.

Green Infrastructure Thresholds

0% Green

No Green
Impervious surface 90-100%
Tree canopy coverage 0-10%



Grass berm only
Impervious surface 80-90%
Tree canopy coverage 0-10%



Minimal Green, grass berm + only borrowed green
Impervious surface 80-90%
Tree canopy coverage 0-10%



Grass berm + Irregular street trees (with some borrowed green)
Impervious surface 80-90%
Tree canopy coverage 0-10%



Parks & Open Spaces

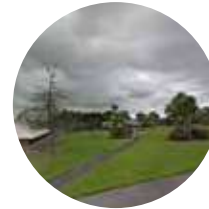

Grass / turf park, minimal planting

MINIMUM GREEN THRESHOLD

Grass berm + street trees at maximum of 20 meter centers (some borrowed green +/- irregular shrub planting)
Impervious surface 70-80%
Tree canopy coverage 10-30%

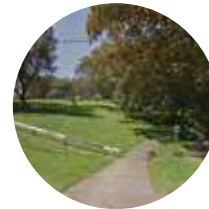

Picturesque Park - Grass with assorted canopy trees with some low level planting.

PREFERRED GREEN THRESHOLD

Grass berm + street trees at 10 - 15 meter centers with continuous canopy cover (some borrowed green +/- irregular shrub planting)
Impervious surface 70-90%
Tree canopy coverage greater than 30 - 40%



Tree Park - Continuous canopy with grass and assorted low level planting.

Integrated water sensitive urban design +/- street trees at maximum 10 - 15 meter centers with continuous canopy cover (some borrowed green)
Impervious surface less than 70%
Tree canopy coverage greater than 40%



Wetland / Water park - Natural or constructed wetland with biodiverse planting.

Streets



Forest Park - Multi layered self regenerating forest

'100%' Green

PART TWO

NETWORK PLANNING



2.0

INTRODUCTION

The Network Planning section provides an outline of Local Path types, as well as a step-by-step illustration of how to plan a Local Path network through existing and new neighbourhoods.

This is not intended to be an exhaustive or definitive process, but rather a description of how interested individuals and/or professionals can begin to imagine the development of a Local Paths project that supports improved walking and cycling in their neighbourhood while creating more pleasant and friendly neighbourhoods.

As stated, this chapter falls into two parts.

Part one, provides an overview of the broader context for Local Paths, including the principles and performance standards that should guide the design of a Local Path.

Part two, Network Planning, is situated within the framework laid out in Part One, providing a step-by-step methodology for guiding designers and individuals in the planning and design of a Local Path network.

2.1

LOCAL PATH TYPES

Whether on a street or through a park, there are a number of Local Path types that make up a Local Path network. While Local Paths vary in detail there are essentially three main types of Local Paths: an Alternative Route provides an alternative to a busy arterial, a Destination Feeder connects neighbourhoods to local destinations, and a Route Feeder connects neighbourhoods to Express Paths.

Alternative Route

Provides an alternative to a busy arterial.

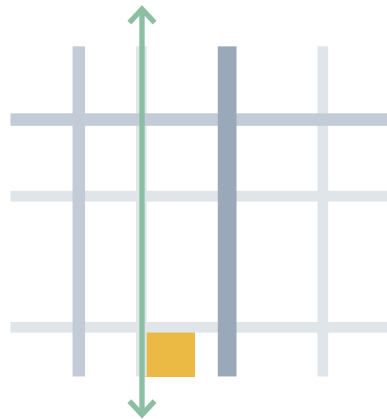

Destination Feeder

Connects neighbourhoods to local destinations.

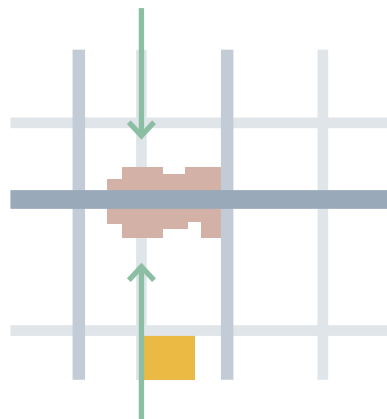

Route Feeder

Connects neighbourhoods to Express Paths.

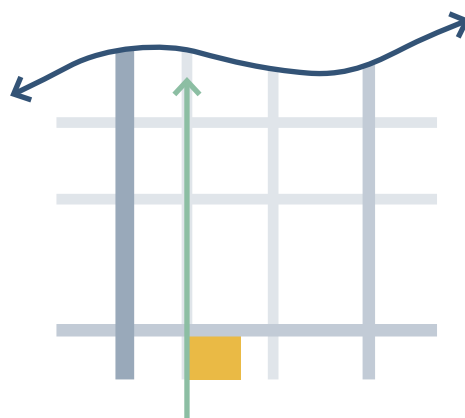

Key

- Regional Arterial
- Connector
- Local Street
- School
- Town Centre
- Local Path
- Express Path

2.2

NETWORK PLANNING

The following outlines a methodology to plan a neighbourhood Local Path.

An effective Local Path requires careful planning to ensure it fulfills the key outcomes of connecting neighbourhoods to key destinations and transport networks. The process for planning a Local Path can be broken down into a sequence of key steps as shown below.

Engaging the community for which you are designing a Local Path can be done in a number of ways throughout the process of planning your Local Path. Suggested methods are included for the different steps in this process.

STEP 1

Identify Neighbourhood Destinations & Connections

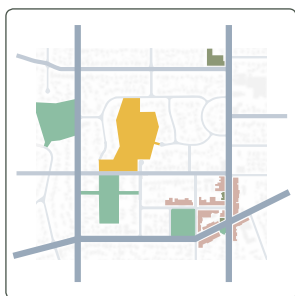

STEP 2

Collect and Analyse Base Data

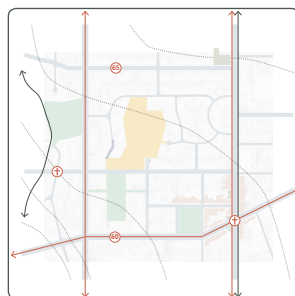

STEP 3

Identify Local Path Routes

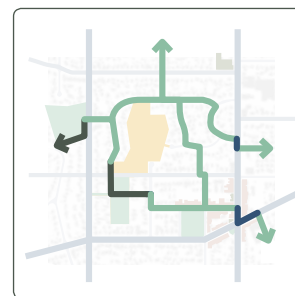

STEP 4

Identify Key Design Requirements

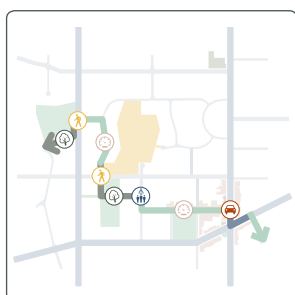

STEP 5

Putting it All Together: Applying the Tools

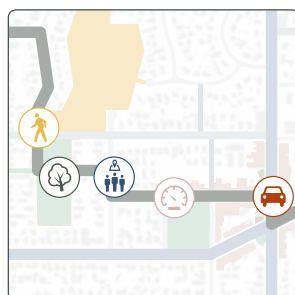

Common Concerns

Will emergency response time and routes be affected?

Where possible Local Paths should avoid all emergency service routes. Where this is not possible, emergency services requirements will be integrated into the design of all Local Paths. Official and de facto emergency response routes will be identified in the surrounding network. If required, alternative routes will be identified and agreed with emergency responders. Trial installations of street diversions, medians, and other tools can help determine that they can work with emergency vehicles.

Will diverting vehicles create traffic on adjacent neighbourhood streets?

When designing a Local Path, a local network-wide analysis will be conducted that analyses extent and magnitude of traffic diversion onto affected streets. A trial installation can be useful here to determine the implications. In some cases, vehicle diversion may not be the most effective tool for the Local Path, and other traffic calming, education campaigns or enforcement actions could be implemented. In suburbs that do not have alternative routes for either Local Paths or motor vehicle traffic, utilisation of new non-motorised routes through parks, acquisition of utility corridors, the introduction of connections between cul-de sacs, and in some cases through the introduction of new streets may need to be investigated.

Step 1_ Identify Neighbourhood Users, Catchments, Destinations and Connections

To attract users, Local Paths first and foremost must provide transport utility.

The development of a Local Path should begin with the identification of intended users, catchments, local origins and destinations, as well as transport connections.

Broad desire lines should be drawn to illustrate the potential to connect neighbourhoods to destinations. Consider the attraction and utility of the destination. How many people are going here? Are they travelling daily or just on weekends? In many cases multiple destinations can be linked up to expand the functionality of the network. Connection to wider transport networks such as core bicycle facilities (Express Paths) and transit stations and stops should also be included.

Engaging the Community

- Open days
- Design workshops etc
- Street/block party (see page 40)
- Play street (see page 40)
- Transition street (see page 41)

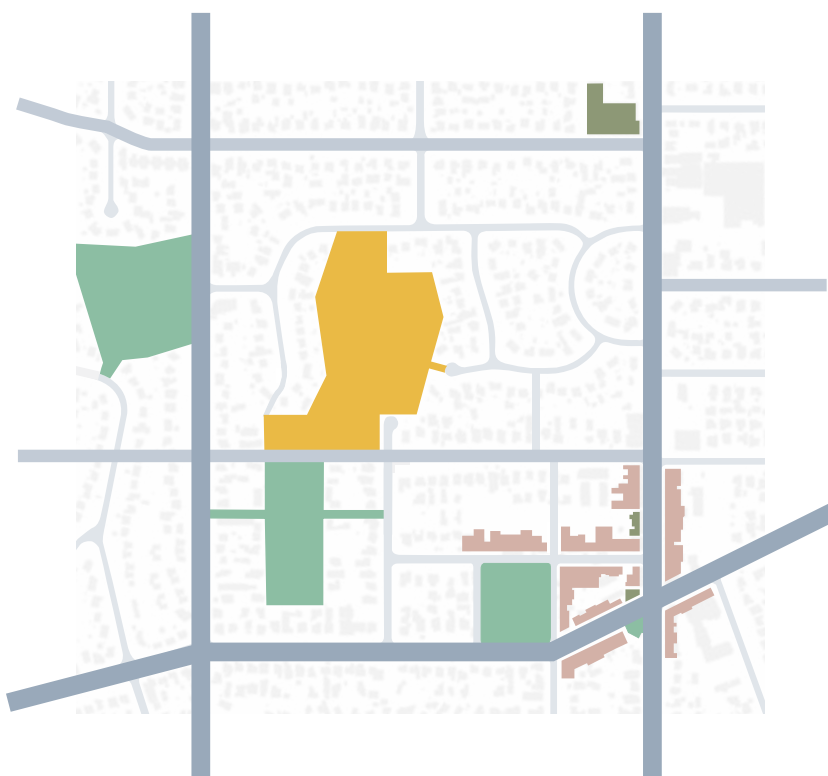

Land Use + Key Destinations

- Residential
- Open Space
- Place of Worship
- Town Centre
- School

Surrounding Street Grid

- ▬ Regional Arterial
- ▬ Connector
- ▬ Local Street

Step 2_ Collect and Analyse Base Data

A base plan should be prepared including the following information. Most information can be found on the **Auckland Council GIS map viewer**, the **Proposed Auckland Unitary Plan viewer** and other online mapping tools. This information includes:

- Existing and future land uses.
- Surrounding street grid .
- Property parcels and land ownership.
- Topography.
- Existing infrastructure, including existing paths and below ground infrastructure such as storm water, power and waste water
- Existing and/or preferred pedestrian and cycling routes.

Other valuable information to collect includes (it is likely that this will require working with Auckland Transport and/or engaging a transport consultant):

- Wider transport network plans: cycle network, public transport plans.
- Traffic control inventory: stops signs, posted speeds, signals.
- Existing daily traffic volumes and peak period turning counts.
- Pedestrian and cycle counts and observations.
- Auckland Transport school travel data.
- Traffic speed data (radar).
- Crash history.
- Public Transport routes.
- Official and de facto emergency response routes.
- Local plans and/or strategies such as plan changes; town centre or precinct plans; park designs etc.
- Census Data.
- Emergency vehicle routes.
- Wider urban streetscape planting and tree cover.
- Areas of significant vegetation and “urban forests”.

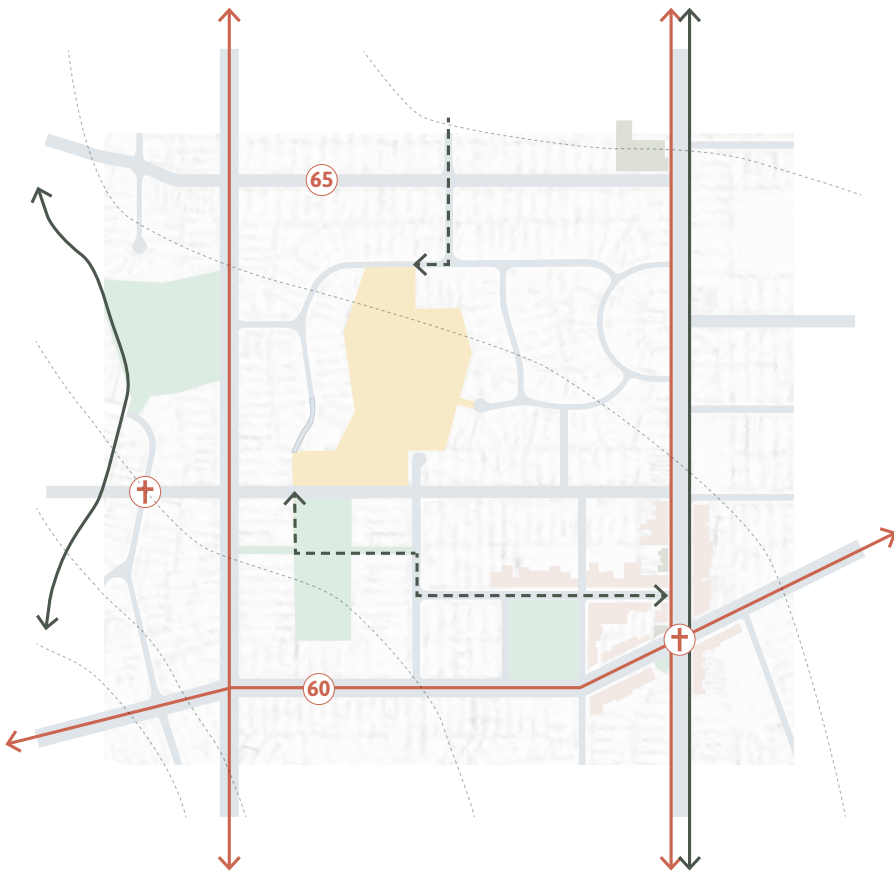

Working with Auckland Transport

This step-by-step process is intended for anyone to be able to follow to plan their Local Path. However, some of the base data will need to be collected and analysed by a professional planner. All data will be analysed to provide an assessment of the technical feasibility and benefits of implementing a Local Path. The data will also be used to understand the level to which traffic calming and traffic diversion is required to meet the required performance standards and the desired conditions.

Land Use + Key Destinations

- Town Centre
- Open Space
- School
- Place of Worship

Surrounding Street Grid

- Regional Arterial
- Connector
- Local Street

Base Data

- Property Parcels
- + Crash History
- 65 Traffic Speed Data (Radar)
- Commuter Bike Path
- Frequent Bus Network
- Existing ped/cycle routes
- 5m Contour

Vehicle Volumes + Speeds

	Typical Volume (ADT)	Typical Speed (km/h)
Regional Arterial	10,000 - 15,000	50
Connector	2,000 - 5,000	50
Local Street	500 - 2,000	40 - 50
Two-way Cycleway	0	0

Step 3_ Identify and Evaluate Local Path Routes

Using the broad desire lines between destinations identified in Step 1, with the data sets compiled in Step 2, it becomes possible to identify potential Local Path routes in the existing street network.

Evaluate the routes for the following

Network Utility_ How well does the route connect people to destinations? Does the route connect-up to other cycleways? Are there multiple destinations along the route?

Comfort and Attractiveness_ Do the physical factors (e.g.. slope) of the route support ease of use? Do the activities along the route support safe use during various times of day? (social safety).

Directness (both in time and distance)_ Is the route direct and legible? How big of a detour does the route take compared with comparable routes?

Feasibility_ How practical is the proposed alignment? Reducing vehicle speeds and volumes is easier if the existing conditions are close to the performance standards.

Engaging the Community

Open days and design workshops etc can be used to engage and gain community input in identifying Local Path routes

Working with Auckland Transport

At this stage a professional planner will be required to help identify and evaluate potential Local Path routes.

Local Path Types

- Express Path
- Local Path_ Street
- Local Path_ Open Space
- Trail

Note_ As discussed, the Local Path Design Guide deals only with the 'Local Path_ Street' and 'Local Path_ Open Space' typologies

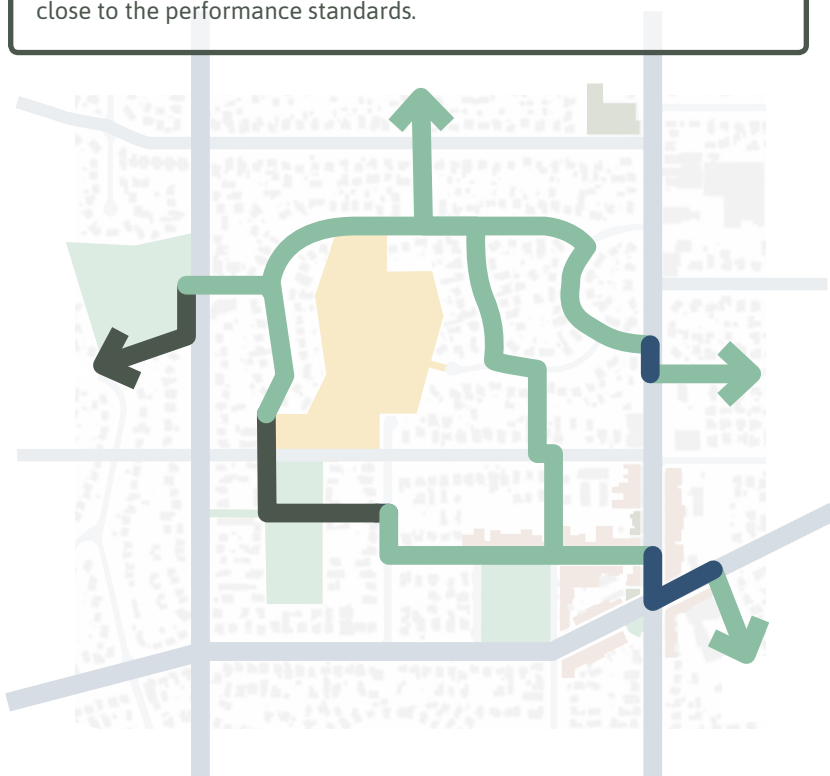

Step 4_ Identify Key Design Requirements

Along your chosen route, identify key requirements of the Local Path design, where necessary including:

- Placemaking Opportunities.
- Traffic Reduction Measures.
- Speed Reduction Measures.
- Safe Street Crossings.
- Requirements for Signage and Path Markings.





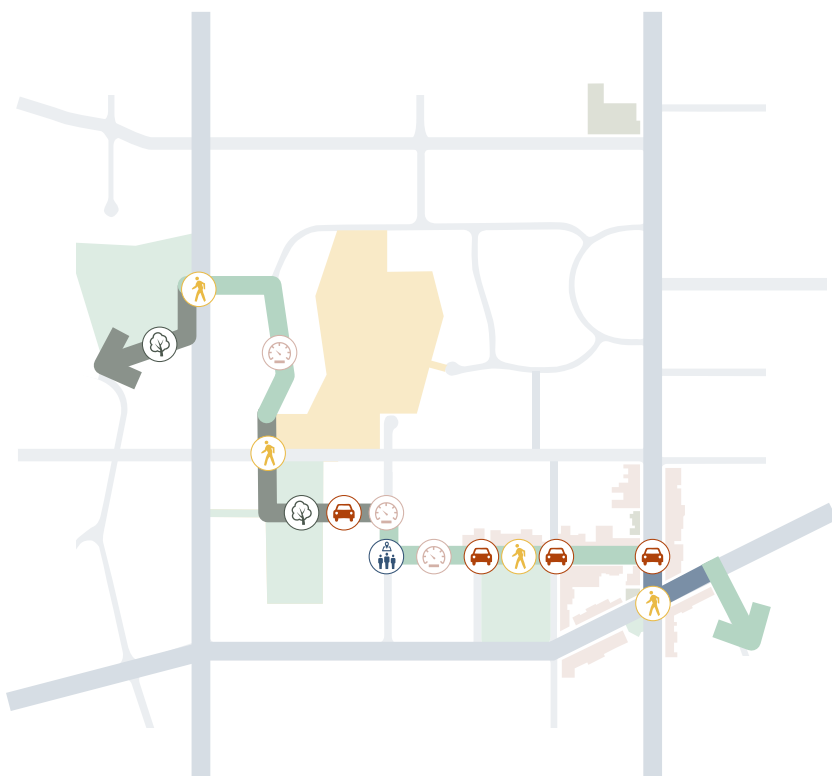

At this stage of design process, it is important to obtain high-level cost estimates for your Local Path.

Engaging the Community

If you haven't already, start identifying opportunities for placemaking (see Tools for Placemaking section on page 32).



Key Design Requirements

-  Reduce Traffic Volumes
-  Reduce Traffic Speeds
-  Crossing the Street
-  Signage & Road Markings
-  Placemaking
-  Parks

Step 5_ Putting it All Together: Applying the Tools

With the Local Path route determined and the key design requirements identified, specific features from the Local Path Tool kit are specified to achieve the desired result. Using the tools found from page 30 onwards, identify a range of tools to use in the design of your Local Path. At this stage of the design process, it is important to obtain cost estimates for specific tools.

Identified Tools



1 Park Entry/Exit



2 Kerb Extension



3 Speed Cushion

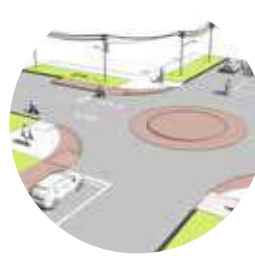

4 Round About

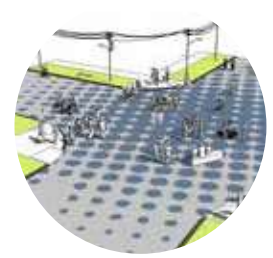

5 Tactical Urbanism



6 Pinch Point



7 Cul De Sac



8 Signalised Crossing



9 Diagonal Diverter



10 Cycle Crossing

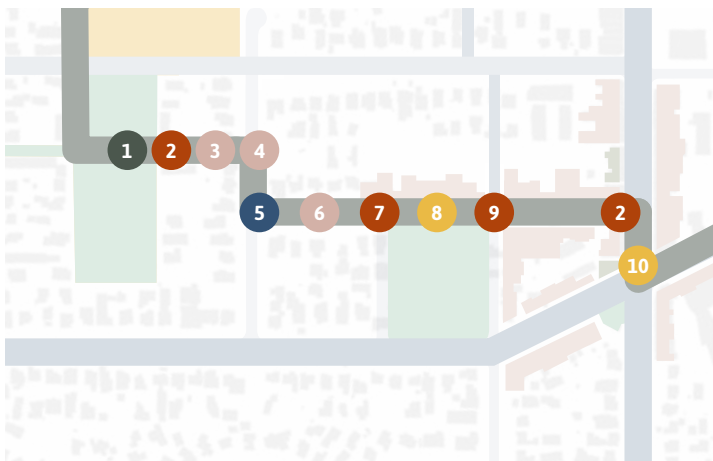

Key Plan

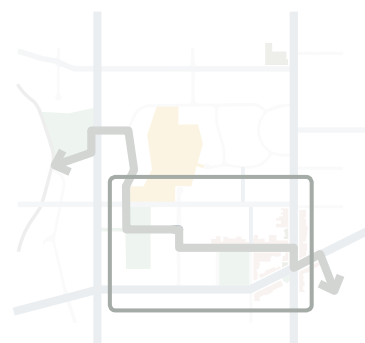

Putting it All Together: Neighbourhood View*

This example diagram depicts how a range of tools can be combined to form a Local Path.



* Please note that tools expressed in this diagram are indicative only and don't represent preferred numbers, locations or combinations of tools.

PART THREE

LOCAL PATH TOOL KIT



3.0

INTRODUCTION

The Local Path Tool kit provides the tools needed to create a successful Local Path. These tools are organised into six categories - placemaking, parks, traffic volume reduction, traffic speed reduction, crossing the street, and signage and path markings. Where possible, variations of each of the tools are included to suit different street typologies, contexts, and budgets. Where appropriate concept 3D views and examples are provided to show distinct design features. Each tool also comes with a set of design considerations, design parameters and an indicative relative cost.



Tools for Placemaking



Tools for Parks



Tools to Reduce Traffic Volume



Tools to Reduce Traffic Speed



Tools for Crossing the Street



Signage and Street/Path Markings

3.1

TOOLS FOR PLACEMAKING

The Tools for Placemaking section provides guidance for engaging mana whenua and working with communities, as well as improving the amenity, character and ecological function of a Local Path. The Te Aranga Design Principles outline an agreed framework for partnering with mana whenua. Tactical urbanism, intersection repair and street based initiatives outline a range of tools for actively engaging the community through the planning, design and implementation phases of a Local Path project. Water sensitive urban design, street trees, pollinator pathways and berm gardening all provide tools for improving the character and amenity of a Local Path, as well as integrating ecological function into a Local Path.

[Te Aranga Design Principles](#)

[Tactical Urbanism](#)

[Street-based Community Initiatives](#)

[Water Sensitive Design](#)

[Street Trees](#)

[Pollinator Pathways](#)

[Berm Gardening](#)

Te Aranga Principles

This design framework provides the opportunity for mana whenua to ensure the incorporation of an appropriate narrative that will enhance the intrinsic and cultural fabric, engender a sense of place, recapture those aspects of their cultural history that are embedded in the whenua and upon the korowai of their people, past, present and future. In order to effectively integrate the Te Aranga Design Principles into the design of a Local Path, it is critical to engage mana whenua early on during the design process.

Cost ● ○ ○ ○ ○

See pages 125 - 133 for more information

Auckland Design Manual

The key objective of the Te Aranga Maori Design Values and Principles is to enhance the protection, reinstatement, development and articulation of mana whenua cultural landscapes and to enable all of us (mana whenua, mataawaka, taulwi and manuhiri) to connect with and to deepen our collective appreciation of 'sense of place'.

Within the Auckland Design Manual (ADM) the following core Maori values have informed the development of the outcome-oriented Te Aranga Maori Design Principles:

**Rangatiratanga | Kaitiakitanga | Manaakitanga |
Wairuatanga | Kotahitanga | Whanaungatanga | Matauranga**

For each of the seven design principles outlined on the following page, 'place based applications' will be established by and with mana whenua.

Mana Rangatiratanga - Authority

Outcome

The status of iwi and hapu as mana whenua is recognised and respected.

Attributes

- Recognises Te Tiriti o Waitangi and the Wai 262 Ko Aotearoa Tenei framework for the Treaty Partnerships in the 21st Century Aotearoa New Zealand as the basis for all relationships pertaining development.
- Provides a platform for working relationships where Mana whenua values, world views, tikanga, cultural narratives and visual identity can be appropriately expressed in the design environment.
- High quality Treaty based relationships are fundamental to the application of the other Te Aranga principles.

Whakapapa - Names and Naming

Outcome

Maori names are celebrated.

Attributes

- Recognises and celebrates the significance of Mana whenua ancestral names.
- Recognises ancestral names as entry points for exploring and honouring tapuna, historical narratives and customary practises associated with development sites and their ability to enhance sense of place connections.

Taiao - The Natural Environment

Outcome

The natural environment is protected, restored and / or enhanced

Attributes

- Sustains and enhances the natural environment.
- Local flora and fauna which are familiar and significant to Mana whenua are key natural landscape elements within urban and / or modified areas.
- Natural environments are protected, restored or enhanced to levels where sustainable Mana whenua harvesting is possible.

Mauri Tu - Environmental Health

Outcome

Environmental health is protected, maintained and / or enhanced.

Attributes

- The wider development area and all elements and developments within the site are considered on the basis of protecting, maintaining or enhancing mauri.
- The quality of wai, whenua, ngahere and air are actively monitored.
- Water, energy and material resources are conserved.
- Community wellbeing is enhanced.

Mahi Toi - Creative Expression

Outcome

Iwi/hapu narratives are captured and expressed creatively and appropriately.

Attributes

- Ancestral names, local tohu and Iwi narratives are creatively reinscribed into the design environment including: landscape; architecture; interior design and public art.
- Iwi / hapu mandated design professionals and artists are appropriately engaged in such processes.

Tohu - The Wider Cultural Landscape

Outcome

Mana whenua significant sites and cultural landmarks are acknowledged.

Attributes

- Acknowledges a Maori world view of the wider significance of tohu / landmarks and their ability to inform the design of specific development sites.
- Supports a process whereby significant sites can be identified, managed, protected and enhanced.
- Celebrates local and wider unique cultural heritage and community characteristics that reinforce sense of place and identity.

Ahi Kā - The Living Presence

Outcome

Iwi/hapu have a living and enduring presence and are secure and valued within their rohe.

Attributes

- Mana whenua live, work and play within their own rohe.
- Acknowledges the post Treaty of Waitangi settlement environment where Iwi living presences can include customary, cultural and commercial dimensions.
- Living Iwi/hapu presences and associated kaitiaki roles are resumed within urban areas.

Tactical Urbanism

Tactical urbanism, often described as the 'lighter, 'quicker, cheaper' approach to placemaking, is a design methodology that involves a number of temporary 'design experiments'. These 'experiments' test the design, programme and arrangement of a public space (such as a street) in a low-cost, low-risk and low-commitment way. The aim is that these experiments are measured for effectiveness and those that work are either left in place, or implemented in a more permanent manner. Tactical Urbanism can be adopted by Council or local boards as a 'top-down' strategy, or by citizens and community groups as 'bottom-up', grassroots initiatives or a combination of the two, possibly involving others as well.

Cost ● ● ● ● ●

See page 125 - 133 for more information



Design Considerations

- Engage with adjoining landowners where possible, to understand and respond to any concerns raised before commencing.
- Engage with and gain approval from traffic operations and safety at Auckland Transport before commencing.
- Create criteria for what success might look like before the project is implemented so there is desired outcome to measure against.
- Set up a means of monitoring and evaluating the relative success or otherwise of the project.

48 x 48 x 48



48 hours



48 days



48 weeks

48 x 48 x 48 is an established methodology utilised to trial possible solutions in the public realm. Starting with a temporary development and a set of success criteria, an intervention lasting 48 hours is implemented and monitored. Successes are measured and the design is refined and a semi-permanent change is then installed, occurring for 48 days. If this works, a more permanent change is implemented for 48 weeks - roughly one year. This process can test the success of a Local Path strategy right within the neighbourhood in question, after which it can then be made permanent. One alternative to this approach is 1 day, 1 week, 1 month, 1 year.

CASE STUDY

INTERSECTION REPAIR: PORTLAND, OREGON, USA

Key Features

- \$1000** Approx. cost to implement an Intersection Repair.
- 4-way** collaboration between Portland Bureau of Transportation, core neighbourhood group, wider neighbourhood and City Repair Project.
- 100+** participants contributed to 8th and Holman Intersection Repair.
- 4** properties adjacent to the intersection on-board with project.
- 60-80%** wider neighbourhood support (within a 1 - 2 block radius).
- 1** permit only per year required by PBOT.

Results

- 100%** of neighbourhoods in Portland are able to implement Intersection Repairs.
- 41** Intersection Repair projects implemented in Portland in 2012.
- Seattle** Department of Transportation the second city to formally adopt Intersection Repair.
- 65%** said their neighbourhood was “an excellent place to live”, versus 35% in an adjacent neighbourhood.
- 86%** of neighbours adjacent to Sunnyside Piazza Intersection Repair in excellent health, compared to 70% in other comparable intersections.

Top Down, Bottom Up



Street Based Community Initiatives

There are a growing number of initiatives that can be championed and implemented directly by citizens and communities that re imagine our streets as more than simply spaces for motorised vehicles, but as valuable places that cater to people of all ages and abilities and for a wide range of activities. The Walking School Bus and Bike Train initiatives have also emerged as ways to create fun, safe, and practical alternatives to driving to school. Below are four examples of street-based initiatives that can be directly employed by communities and citizens.



STREET/BLOCK PARTIES

Block or street parties temporarily reclaim a neighbourhood street entirely from vehicle traffic. By blocking entrances to a small portion of a residential street, the street is reclaimed for the enjoyment of the community. Block or street parties are often used as a way to celebrate, unite, and strengthen the community by creating connections between neighbours. In some parts of the US, Police departments will subsidise these events as a crime prevention method.

Learn more_ www.seattle.gov/transportation/stuse_blockparty.htm

PLAY STREETS

Play Streets began in the 1930's as a response to a rising concern about the number of children being killed in road accidents. By 1963, there were 750 play streets in England and Wales which allowed local authorities to close residential streets to traffic between 8am and sunset. As car ownership increased, they became obsolete by the 1980's. Today, they are now enjoying a resurgence in places like the UK and the US. In 2011, local parents in Bristol, again concerned about their children's health and lack of outside play, decided to revitalise the Play Streets movement. There are now 40 play streets in Bristol alone and the concept is spreading to other streets in London, Oxford, Sussex and beyond. Typically a play street involves closing a street for a couple of hours a week / month. Play Streets provide a fun gathering place for community, as well as mitigate against childhood obesity.

Learn more_ www.londonplay.org.uk/content/30290/our_work/recent_work/play_streets/play_streets

Cost ● ○ ○ ○ ○

See page 125 - 133 for more information

Recommended Usage

- On a low-traffic residential street.
- As a means of initiating a Local Paths initiative.

Design Considerations

Must_

- Ensure that two individuals are assigned to each end of the street to remove barricades in the case of an emergency.

Must not_

- Be on an arterial street.
- Close the intersection.
- Have a bus stop located on the block.

TRANSITION STREETS

Transition Streets is a new initiative to emerge out of the Transition Movement. The Transition Movement, also known as Transition Culture and Transition Towns, is an international movement and framework for a community-led approach to envisioning and implementing an on-the-ground response that helps to build resilience in the face of significant global challenges such as peak oil and climate change. Transition Streets involves groups of friends and / or neighbours meeting every few weeks to develop and implement a plan to make easy changes to improve how they use energy, water, food, packaging, transportation, and more. The goal is to engage those that may not see themselves as green to make changes to live more sustainably. In the UK over 550 households have already participated in the Transition Streets movement. They saved an average of \$938/year, reduced their household carbon emission by an average of 1.3 tons, and just as importantly, developed a stronger sense of community.

Additional material to begin your own Transition Street_

- *The Transition Companion* - Rob Hopkins
- www.transitionnetwork.org
- www.transitionus.org
- handbook.transitionstreets.org

BIKE TRAINS

Although not used in Auckland or NZ, bike trains are gaining in popularity around the world. Very similar to a Walking School Bus, a bike train is a group of people that bike together on a pre-planned route to school. There are meet up points along the way where families join the train. Bike Trains attempt to create a fun, comfortable, safe way to create a community of riders. Kids arrive to school more attentive and ready to learn, and schools are safer because you have more eyes on the street. By riding together in a pack, the bike train achieves safety in numbers and contributes to making drivers aware that people on bikes are on the road. In addition, riders learn more about how to safely traverse urban areas by bike.

Learn more about Bike Trains_

- www.biketrainpdx.org
- www.saferoutestoschools.org
- www.walkbiketoschool.org/sites/default/files/SRTS_BikeTrain_final.pdf



Water Sensitive Design

“Water Sensitive Design (WSD) is an interdisciplinary design approach, which considers stormwater management in parallel with the ecology of a site, best practice in urban design, and community values. WSD aspires to ensure multiple public benefits from stormwater management, and to develop a unique ‘sense of place’ for our communities. A WSD approach takes into account the multiple objectives influencing project outcomes, including urban design, landscape amenity, and community issues and aspirations. In this way, stormwater management is targeted to where the greatest benefit can be achieved for both community and ecological outcomes”

- Water Sensitive Design for Stormwater, 2015

Design Considerations

- Reducing Impervious Surfaces - One of the most effective ways of improving the environmental performance of our streets is to reduce the amount of impervious surfaces and replacing it with soft landscaped areas and WSD devices.
- WSD devices should utilize plants appropriate to treat contaminated stormwater.
- The long-term growth patterns of all plants should be considered. Cost-effective plantings that can be maintained on a low frequency rotation should be utilised.
- Utilise plants that are self regenerating in order to fill out the planting area and compete with invasive species.
- Ensure that the character of the WSD devices consider the character of the neighbourhood it is situated in.
- In order to continually improve WSD practices, monitoring and evaluation should be considered early in the design process.
- Consideration should be given to the locations of all existing below-ground and above-ground services.
- Mulch used in WSD devices should be gravel where inflows are anticipated to avoid scouring, as well as to ensure the mulch isn't suspended and will not float away.

Cost ● ● ● ● ●

See page 125 - 133 for more information

Design Parameters

- The responsibility for ongoing maintenance and costs need to be agreed with the part of Auckland Council or Auckland Transport responsible for future maintenance of these features, prior to the design being completed.
- Implementation of WSD devices along streets should ideally coincide with existing underground stormwater drainage infrastructure.
- A useful rule of thumb is that 1/12 or approximately 8% of the total area of any given area of impervious surface should be dedicated to bioretention devices such as rain gardens.
- Any planting needs to maintain clear sight lines between different users of the street.



Recommend Usage

The following tools present opportunities to integrate WSD devices into the design of a Local Path network.

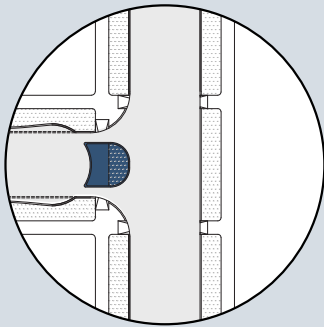

Cul-De-Sac

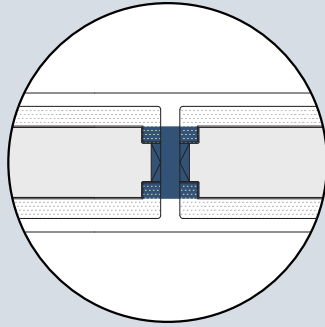

Raised Crossing

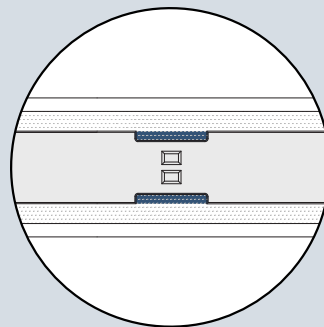

Speed Cushions

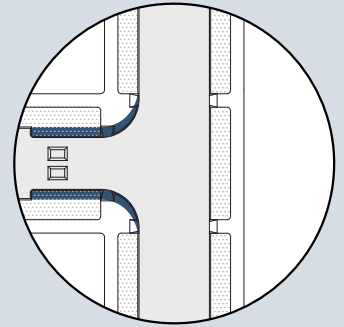

Kerb Build Out

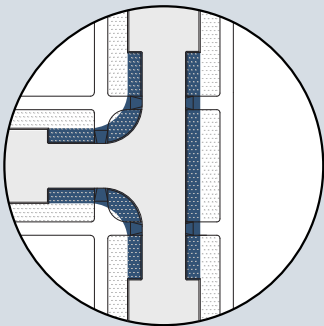

Kerb Build

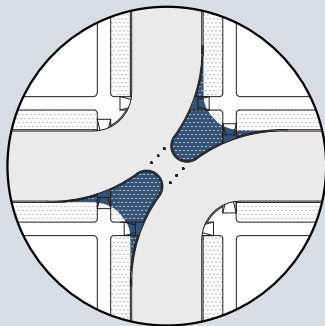

Diagonal Diverter

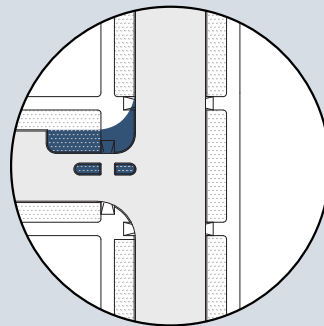

Kerb Build Out

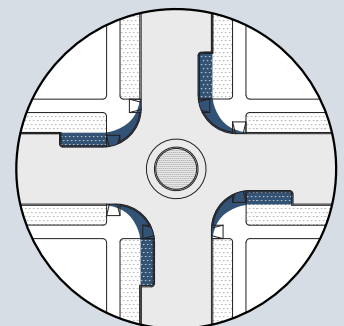

Roundabout Build-outs

Recommended Devices

The following list highlights five of WSD devices suitable for inclusion in Local Path designs and streetscapes upgrades.



Raingardens



Carbon Filter



Permeable Paving



Tree Pits



Bioretention



Street Trees

Street trees can be one of the most effective ways of changing the perceptions and behaviours of drivers and positively contributing to the character, amenity and ecological function of a street. Street trees should be considered a priority feature for any new Local Path. Street trees provide a significant structural element to the streetscape by framing the street, defining space for pedestrians and by helping to separate the footpath from the carriageway. They are symbolic of the landscape's cultural heritage and contribute positively to the ecology of the local environments by providing habitat for wildlife including birds and insects, and reducing the water quantity in the stormwater network. In some cases, the tree canopy coverage can reduce stormwater runoff to the point that additional infrastructure stormwater will not be required.

Design Considerations

- Street trees should be appropriate to the local ecological context and neighbourhood character, and/or have demonstrated good performance in an analogous environment from within the Auckland region.
- Trees should display a consistent form that can be shaped around street lights, traffic and other structures without compromising its form or growth, to an eventual size that will not compromise required street lighting levels. In some situations, a combination of lighting columns with dual fixtures might be best. Placement of any additional lighting or signage poles should be carefully considered on a street where there are established trees to avoid increasing maintenance costs.
- Trees should be resistant to the effects of trampling, physical 'mishandling', vandalism, pollutants and a range of environmental conditions such as drought and wind exposure.
- Trees should not cause unnecessary nuisance or danger to people and property from shedding of limbs or excessive leaf fall, poisonous or toxic seeds etc.
- Deciduous species are preferred over evergreen where winter light penetration is desired. Deciduous species can add seasonal variation in colour, adding to the character of the streetscape.
- Explore how the street trees can form part of an integrated approach to WSD strategy for the street and Local Path network.
- Consideration should be given to the locations of all existing below-ground and above-ground services.
- Consideration needs to be given to the on-going maintenance.

Cost ● ● ● ● ●

See pages 125 - 133 for more information

Design Parameters

- The responsibility for ongoing maintenance and costs need to be agreed with the part of Auckland Council or Auckland Transport responsible for future maintenance of these features, prior to the design being completed.
- Street trees should be planted at regular spacing, ideally 10m, and be appropriately sized for the street.
- Berms for street trees should be at least 1.2m wide. For streets where space is not available, tree pits and other engineered solutions will be required.
- Offset street trees from driveway entries.
- Ensure street trees do not interfere with street lighting, overhead power lines and utilities.
- Provide for root management systems (at least 3m either side of tree) where tree roots could damage adjacent surfaces and utilities.

For more information on trees in road corridors, see the *Vegetation in the Road Corridor Guidelines (Final Draft - June 2014)*.

Key Benefits of Street Trees

- ✓ Reinforces sense of place and city identity
- ✓ Cultural and historical significance
- ✓ Reconnects children with nature
- ✓ Increases biodiversity by providing habitat for birds and insects and by providing ecological linkages between other patches of habitat
- ✓ Sequesters carbon dioxide (a mature tree absorbs approximately 21kg per year)
- ✓ Reduces heat island effect and improves micro climate and comfort of streets
- ✓ Increases property values
- ✓ Reduces the impact of stormwater runoff by intercepting rainwater before it lands on the ground
- ✓ Improves air quality by filtering airborne particulates and pollutants including sulphur dioxide, nitrogen oxides, carbon monoxide, cadmium, nickel and lead



Application for Local Paths

The five street tree applications highlighted below can be integrated into the design of Local Paths and streetscape upgrades.



Seasonal Variation

Sense of Place

Wildlife Habitat

WSD Element

Sense of Scale

Pollinator Pathways

With one third of our food dependent on pollination by insects and other animals, we are deeply dependant on pollinators for our survival. The expansion and intensification of Auckland’s urban environment often results in a reduction of soft landscape spaces in the city. With every bit of soft landscaping we replace with hard urban space, we lose crucial habitat for pollinators. The concept of a pollinator pathway seeks to address this issue by establishing a network of habitat by which pollinators can traverse urban environments. Local Paths present a key opportunity to the concept of a pollinator pathway as the vegetated backbone which links other vegetation to complete a pollinator pathway.

Cost ● ● ● ○ ○

See page 125 - 133 for more information

Design Considerations

- Intensity of urban environment: once an area is above a density threshold, pollinator pathways become less feasible as road corridors are required for other civic functions.
- Maintenance requirements of plants needs to be considered carefully. If there is a risk that maintenance is going to be sporadic then low maintenance native plants are recommended.
- Ensure that the character of the planting considers the specific types and character of planting in the neighbourhood.
- Where possible, employ pollinator pathways to connect existing areas of habitat.
- Consideration should be given to the locations of all existing below-ground and above-ground services.
- Ensure that the selection of plant species provides habitat for the desired pollinators. For example, insects require a selection of plants that will flower year round, where birds require trees that allow them to perch two meters or more above the ground.

Design Parameters

- The responsibility for ongoing maintenance and costs need to be agreed with the part of Auckland Council or Auckland Transport responsible for future maintenance of these features, prior to the design being completed.
- Ensure that the majority of plant species selected are flowering perennials.
- Ensure that the mix of plants provide flowers throughout the year.
- Planting must not impede the movement of people and vehicles.
- Any planting must not damage any utility services or unduly impede access to utility for repair.
- Any planting needs to maintain clear sight lines between different users of the street.
- Agrochemicals such as herbicides or pesticides can negatively impact insect populations and should not be used in the maintenance of pollinator pathways.



Key Objectives for Pollinator Pathways

- ✓ Increase pollinator habitat and biodiversity
- ✓ Establish a network for pollinator connectivity across Auckland
- ✓ Promote pollinator friendly design
- ✓ Raise awareness around the importance of pollinator species
- ✓ Improve amenity and character of Auckland neighbourhoods and communities

Learn more_

- Pollinator Pathway - www.pollinatorpathway.com
- Pollinator Paths - andreajanet Reid.wix.com/lifelines



Opportunities within Local Paths

Opportunity exists to bring pollinator friendly design to the soft landscape design elements including the road verges, berms, planter boxes, street trees, water sensitive design and other landscaped traffic interventions. The application of flowering plants to a combination of these design elements would add pollinator-friendly design along a Local Path.

Reference_ andreajanet Reid.wix.com/lifelines



Wildlife Habitat

Amenity Planting

WSD

Planter Boxes

Street Trees

Berm Gardening

Berm gardening refers to community-initiated management of berms, verges and other landscaped areas within the road reserve (property boundary to property boundary). Internationally, berm gardening is positively recognised for enabling communities to establish local character, building social capital, neighbourhood cohesion and lively streets, increasing property values and providing habitat.

Design Considerations

- Intensity of urban environment: once an area is above a density threshold, berm gardening becomes less feasible as footpaths are required for other civic functions.
- Maintenance requirements of plants needs to be considered carefully. If there is a risk that maintenance is going to be sporadic then low maintenance native plants are recommended.
- Ensure that the character of the planting considers the specific types and character of planting in the neighbourhood.
- Consideration should be given to the locations of all existing below-ground and above-ground services.

Cost ● ○ ○ ○ ○

See page 125 - 133 for more information

Design Parameters

- The responsibility for ongoing maintenance and costs need to be agreed with the part of Auckland Council or Auckland Transport responsible for future maintenance of these features, prior to the design being completed.
- Planting must not impede the movement of people and vehicles.
- Any planting must not damage any utility services or unduly impede access to utility for repair.
- Any planting needs to maintain clear sight lines between different users of the street.



Key Benefits of Berm Gardening

- ✓ Facilitate local character and placemaking amenity.
- ✓ Empowers communities to become stewards of their shared environment.
- ✓ Provides greater opportunity to produce food for local distribution and consumption.
- ✓ Contributes positively to biodiversity through increased habitat and connectivity.
- ✓ Improves water quality through filtration and water quantity through improved infiltration.
- ✓ Actively builds soil and recycles nutrients.
- ✓ Captures and stores atmospheric carbon dioxide.
- ✓ Reconnects children with nature.

Learn more_

- Ron Finley: A guerilla gardener in South Central LA - www.ted.com/talks/ron_finley_a_guerilla_gardener_in_south_central_la?language=en



Application for Local Paths

The range and types of berm planting available to choose from mean that an appropriate design can be found for most wide range of streets and neighbourhoods.



Food Production

Amenity Gardens

Pollinator Pathways

Planter Boxes

Fruit Trees

3.2

TOOLS FOR PARKS

Safe and easy access through Auckland's parks and open spaces is an integral part of Auckland's Local Path network. A Local Path through a park is a path for people on bikes and pedestrians, that can be either separated or shared. Together with the Local Paths on streets, they are designed to create linkages to local centres, parks, and schools as well as between Express Paths.

This section provides technical guidance for the tools required in the design of a Local Path through a park.

For more information on the design of parks and open spaces see the **Auckland Design Manual Parks Hub**.

[Entries / Exits](#)

[Pathway Parameters](#)

[Gradients - Long Fall](#)

[Gradients - Cross Fall](#)

[Level Changes](#)

[Tools for Slowing People on Bikes](#)

[Intersections](#)

[Impermeable Surfaces](#)

[Permeable Surfaces](#)

[Bridges and Boardwalks](#)

[Edge Treatments](#)

[Balustrades, Barriers and Fences](#)

[Lighting and Furniture](#)

[Minor Road Priority Crossing](#)

Entries & Exits

The entry/exit points of a park or open space creates the transition between a Local Path running through a park or open space and a street based Local Path, Express Path or Trail. The entry/exit should provide a smooth transition between the different types of walking and cycling infrastructure and should be safe and accessible to all users. Entry/exit points of a park or open space should be well defined and kept as clear of vehicles as possible. In some circumstances it may be appropriate to emphasise and celebrate the entry/exit point of a park or open space with a public artwork or a one-off sign unique to the place. Bespoke peices could incorporate input from/be produced by a local artist, school or other community members.

Design Considerations

- Entrances to Local Paths should be easily identifiable as a Local Path.
- Where possible, entry and exit points should allow for users of all abilities.
- Entry and exit points should be free of obstructions whilst excluding vehicles. Where possible a people on bikes should be able enter/exit the park or open space without dismounting.
- Entry and exit points should be made free of all stationary and moving vehicles.
- Where vehicle use is likely to compromise either the safety or amenity of the entry/exit point, on street tools for reducing vehicles, reducing vehicle speeds, and crossing the street should be incorporated into the design.
- In some situations, provision will need to be made for emergency response and maintenance vehicles.
- Where possible, central path fixtures such as bollards should be avoided. Only use these when a Local Path is primary access for maintenance and/or emergency vehicles.
- Where appropriate, consideration should be given to the incorporation of way finding signage, infrastructure such as a drinking fountain, landscape features, public artwork or a one-off sign unique to the place.

Cost ● ● ● ● ●

See page 125 - 133 for more information

Design Parameters

- Maximum dimension of unobstructed pathway at entry/exit point to should be no more than 1.4m to exclude vehicle entry.
- The design and layout of entry/exit points should conform to minimum sight lines relative to design speed and should ensure that sight lines are long enough to allow for evasive action if required. Typcial minimum sight line distance is 20m. See Safe Stopping Distances for Cyclists page 15 for more detail.

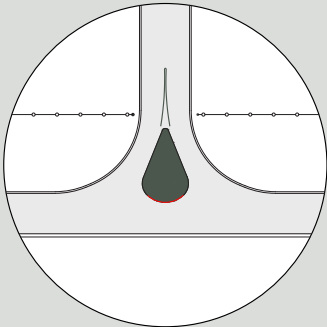
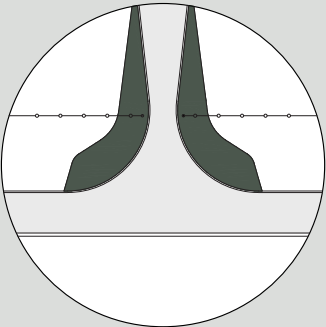
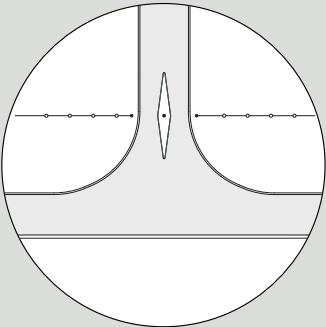
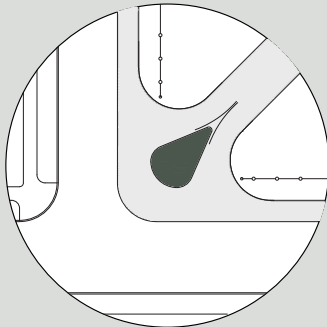
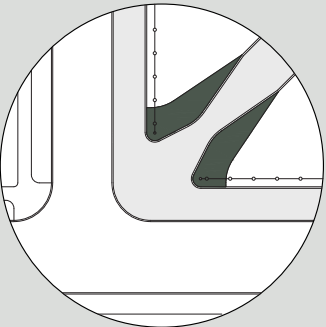
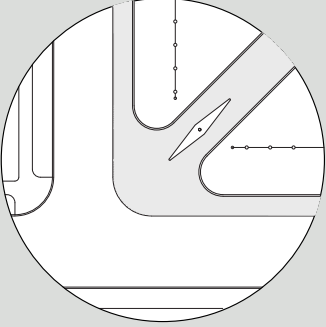
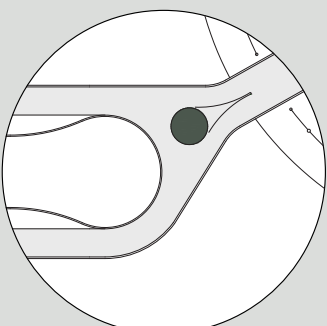
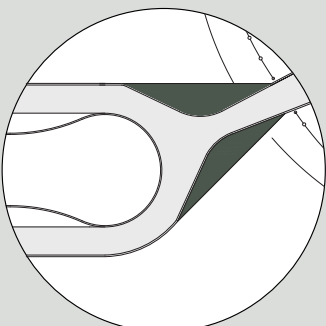
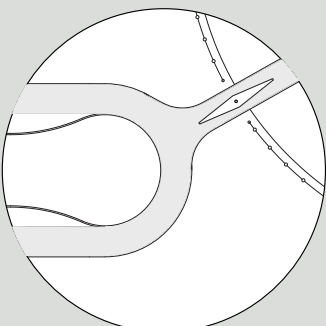

Typical Entry / Exit Point Strategies

	Landscape Feature	Tapper	Central Bollard
Mid-block / T-Intersection			
Corner			
Cul-de-sac			

Landscape features help to demarcate and soften entry and exit points. Typically a landscape feature has a 1.4m wide path either side of a planted garden bed; ensuring that lines of site are maintain.

A taper may be used where planting is desired at an entry / exit point but it is not wide enough for a landscape feature. The design of a tapered entry should gradually narrow the path to a 1.4m width and then taper back out to the standard path width. Taper edges should run at 1:10 to the edge of the path.

Central bollards can create an obstruction to a person on a bike and should be used only where a path is not wide enough to accommodate a landscape feature or tapered entry. A legible tactile surface should be provided to indicate the presence of a bollard. The tactile surface should taper at 1:10 running the length of the path.

Pathway Parameters

The width of the path determines the capacity of the Local Path and it is one of the first question to be asked in the design of a Local Path. Together with the gradient and the material of the path, the width also determines the use and function of the Local Path. While paths can be either shared or separated, shared paths are most common and offer the best balance between usability and cost.

Design Considerations

- The width of the Local Path should balance the requirement for a safe environment with the practical cost of the path. In most cases a 3m unmarked shared path will be adequate.
- In most cases a shared path will be adequate for the desired function and end user, individual paths should be utilised when traffic volumes are high and conflicts are likely.
- The more durable the path material, the narrower the path can be.
- Where possible, paths should be wide enough to avoid the need for Local Path markings.
- In situations where a Local Path must to accommodate maintenance and/or emergency vehicles the Local Path should be sized accordingly.

Design Parameters

- Paths may be narrower than minimum widths where site constraints such as tree roots, property boundaries and heritage items inhibit the ability to build a path to desired widths. Where this is unavoidable, sections of path narrower than the minimum must conform to minimum sight lines relative to design speed. Typical minimum sight line distance is 20m. See Safe Stopping Distances for Cyclists page 17 for more detail.
- Allow an additional 0.5 meters for paths constructed with an impervious surface.
- The height of the user envelope for a cyclist is 2.2m; where a Local Path passes below overhead branches or structures, a minimum overhead clearance of 0.3m (above the 2.2m user envelope height) is required.

Design Parameters Cont.

Design Speed ¹	User Envelope Widths ²			Offset ³	Minimum radii of horizontal path alignment ⁴
	Pedestrian	Two Pedestrians	Cyclist		
0 - 20 km/h	1m	1.5m	1m	0.5m	10m
20 - 30 km/h	1m	1.5m	1m	0.5m	25m
30 km/h +	1m	1.5m	1m	1m	25m +

1. In instances where it is likely that cycle speeds will exceed 30km/h, consideration should be made to introduce curvaceous or indirect alignments, regular curves less than 15m radii. See Austroads for more information.
2. The height of the user envelope for cyclists is 2.2m. See

- Austroads for more information.
3. Offset refers to the minimum distance objects such as fences, furniture, lighting and trees and shrubs must be offset from the edge of the Local Path.
 4. Assumes level terrain.

Preferred Widths and Overhead Clearance Height

Pedestrian - 2m

- Desirable Width - 2m
- Minimum Width - 1.8m
- Minimum Offset - 0.5m^a

a) Utilise only low lying ground covers within the 0.5m strip along the edges of the path.

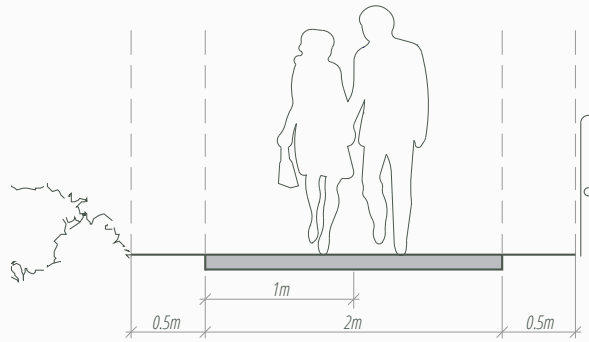

Shared Path - 3m

- Desirable Width - 3m
- Minimum Width - 2.5m^b
- Minimum Offset - 0.5m
- Minimum Clearance Height - 2.5m

b) Lane separator markings should only be used over short lengths of any Local Path where a 3m minimum clear width is not possible due to physical constraints, such as tree routes or property boundaries. A centre line and/or surface treatment which differentiates two sides of the path is required for these sections to establish clear rights of way / directions of movement.

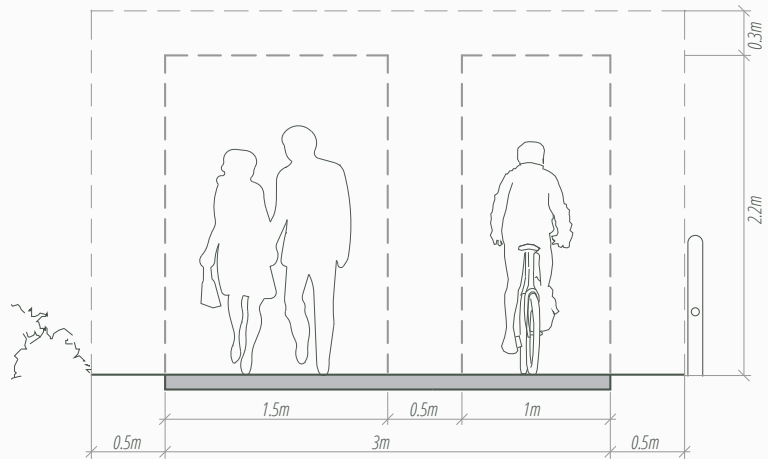

Multi Use - 4m+

- Desirable Width - 4m+
- Minimum Width - 4m
- Minimum Offset - 0.5m
- Minimum Clearance Height - 2.5m

Note: Pedestrians can share multiuse paths with cyclists or pedestrians can share with equestrians. Cyclists tend to spook horses and should not share the same path.

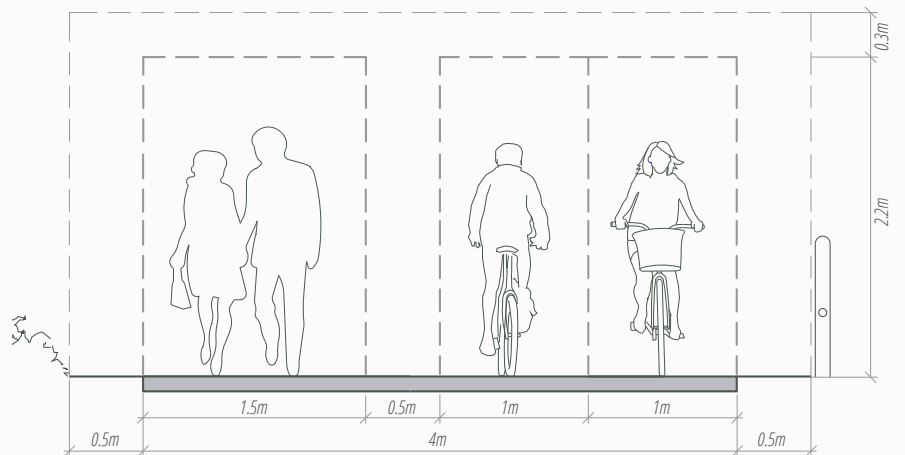

Gradients - Long Fall

The long fall gradient is one of the most important factors determining the accessibility, safety, comfort and experience of the Local Path. Ideally, the design of a Local Path should allow the user to experience the landform of the Park or Open Space with a balance of crests and troughs while the risks of riding down a steep grade and the difficulty of riding up should be minimised.

Design Considerations

- Where possible, the gradients should be accessible to users of all ages and abilities.
- Sharp curves and intersections should be avoided at the bottom of long and/or steep slopes.
- Where possible, long uphill grades should be preceded by a downhill run.
- Gradients should be as flat as possible while minimising earthworks and avoiding or minimising the use of retaining walls.
- Where possible, the crests and troughs along a Local Path should be balanced.
- Where possible, Local Paths paths should be situated above 2 year flood events.
- The choice of material should be appropriate to the gradient of the path.

Design Parameters

- 1:33.3 (3%) is considered the maximum desirable gradient. Gradients of 1:20 (5%) are acceptable but should be avoided unless no other solution is possible or where other considerations such as earthworks make the Local Path unfeasible.
- Paths with gradients greater than 1:20 are recognised as a ramp (refer to level changes section for more information).
- For regulations and additional information on accessible gradients and level changes, please refer to the New Zealand Building Code, Clause D1 - Access Routes.
- The crests of the Local Path must conform to minimum sight lines relative to design speed.

Algebraic Change in Grade

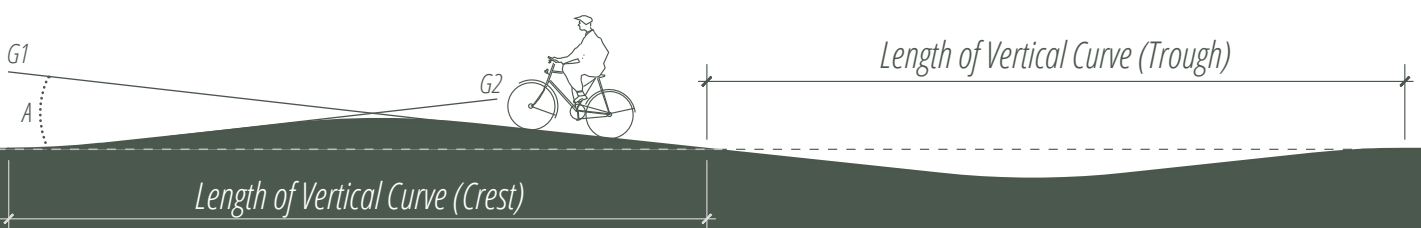

'G1' and 'G2' are Tangent grades in %

| 'A' is the algebraic change in grade

| $A = G1 - G2$.

Gradients for Down Hill Safety

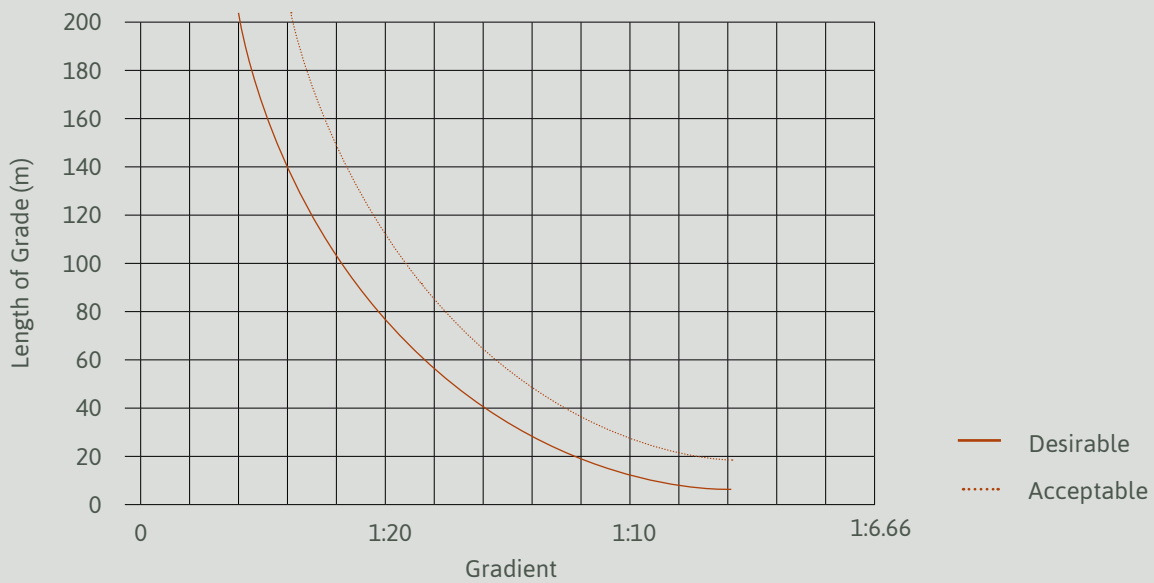

The Crests of Hills

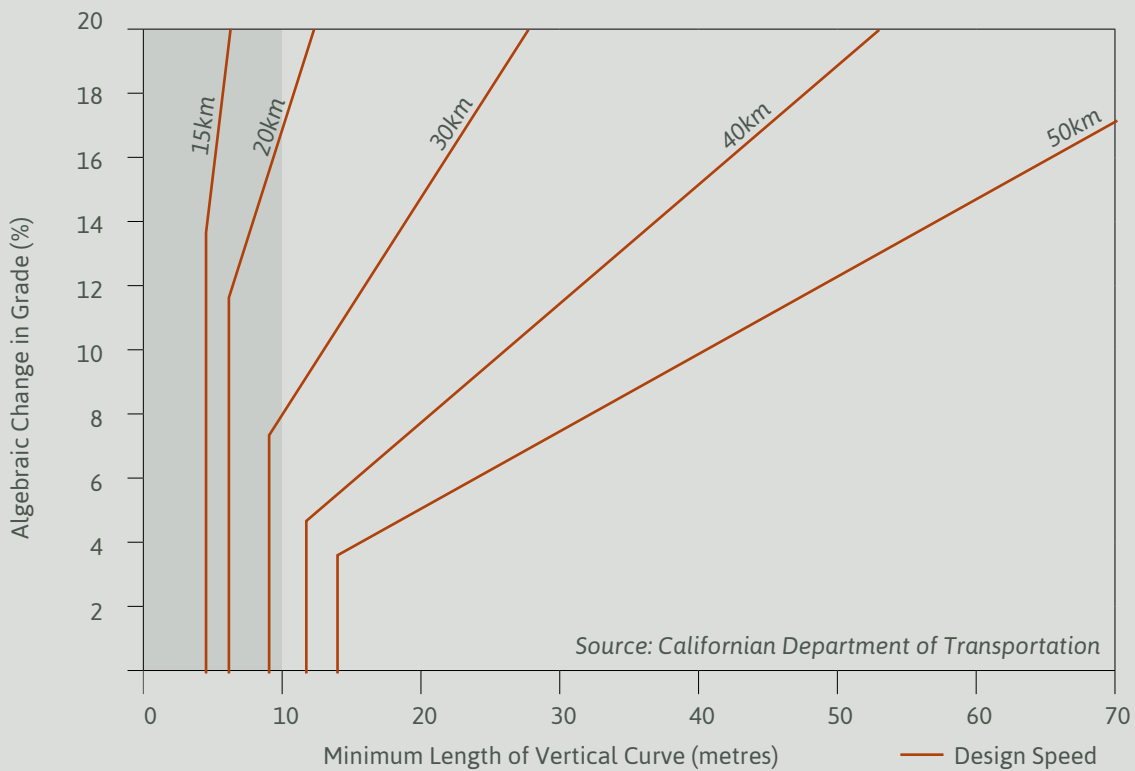

Gradients - Cross Fall

Cross fall refers to the gradient across the Local Path as well as the curvature and ramping of a path around corners. The gradient, surface material and site conditions, in particular soils, vegetation cover and available area, together determines the drainage requirements of the Local Path.

Drainage infrastructure increases the upfront and ongoing maintenance costs for a Local Path. Drainage infrastructure should be minimised and located only where required. Where possible, runoff from paths should be directed towards permeable soils, vegetated areas, WSD devices or other localised means to disperse the water.

Care needs to be taken when using unbound material on paths if there is a risk of material migration which will decrease the safety of the path and require increased maintenance.

Design Parameters

- Paths should be crowned on straight sections and utilise cross falls on curves.
- The cross fall of paths should be as flat as practical while allowing ensuring rainwater drains off the surface:
 - The preferred cross fall is 1:50 (2%)
 - The maximum cross fall is 1:8 (12.5%)
- Some allowance should be given for greater than maximum cross fall over short sections of the path if on-site conditions don't allow for less severe cross falls.
- Impermeable Surfaces:
 - Concrete: 1:50 - 1:25 (2% - 4%) are adequate for drainage. 1:80 (1.25%) shallowest to allow drainage.
 - Timber: The profile and gaps between decking boards will allow the surface to drain.
- Permeable Surfaces:
 - 1:20 (5%) is the shallowest cross fall to allow for drainage and is the optimum cross fall to maintain slip resistance and reduce the risk of material migration.
- Super elevation should not exceed 3% on paths that are to be shared with Accessible routes for wheelchairs and mobility scooters. This may require increasing curve radius.

Design Considerations

- The choice of material should be appropriate to the gradient of the path.
- Where soil and space allow, drain to permeable soils, vegetated areas grass areas or other WSD devices for bio retention - natural filtration, infiltration into ground and/or evapotranspiration.
- Where localised risk of erosion exists, utilise stone rip-rap to slow and dissipate water flows.
- Where water runoff drains naturally across the line of the path, consider pervious paving, planting, filter drain or cross culvert to prevent seepage across path surface.

Cross Fall and Drainage

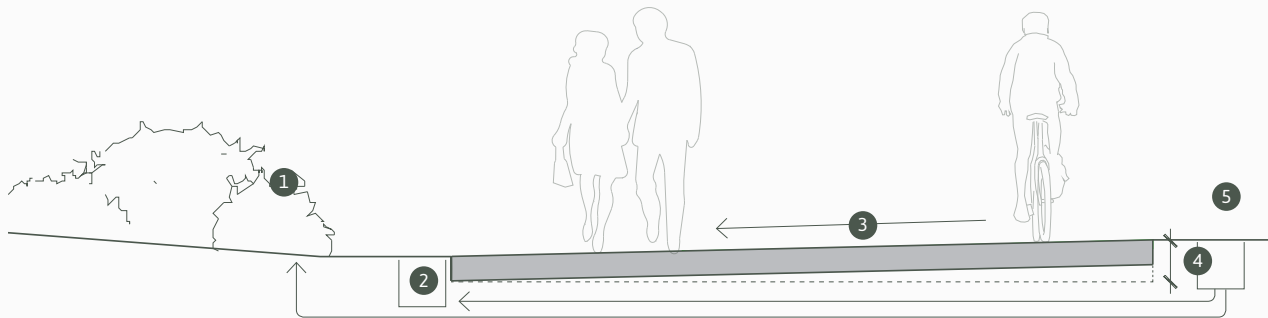

- 1 Where soil and space allow, drain to permeable soils, vegetated areas, grass areas or other WSD devices.
- 2 Where 1 is not possible, drain to existing stormwater system.
- 3 Cross Fall.
- 4 Super elevation at curves.
- 5 Pervious paving, filter drain or cross culvert to prevent seepage across path surface. Water should be diverted to permeable soils, vegetated areas, WSD interventions or the stormwater network.

'Super elevation' at Curves

The design of the curvature and ramping of a path around corners should consider the interplay between the long fall, the cross fall and design speed and the radius of the curve - the culmination of these factors is called the 'Super elevation at Curves' and is important for accessibility, safety, comfort and experience of the Local Path. Super elevation should not exceed 3% on paths that are to be shared with accessible routes for wheelchairs and mobility scooters. This may require increasing curve radius.

Speed (Km/h)	Super elevation (%)				
	2	3	4	5	6
	Minimum Radius (meters)				
20	10	9	9	9	9
30	24	23	22	21	21

Level Changes

A level change is a section of the Local Path that exceeds a maximum of 1:20. A level change can be expressed through either a series of ramps and/or steps. Where stairs are unavoidable provision should be made to allow people on bikes to walk their bike either up or down the stairs and where practical, an alternative route should be provided for those with physical disabilities.

Design Considerations

- Test for alternate routes to ensure that there is no alternative.
- Minimise earthworks and where possible avoid or minimise the use of retaining walls.
- In most cases, a ramp or a series of ramped paths are preferable to stairs. The only circumstances where a stair might be chosen over a ramp, is in situations where topography mean a ramp is not possible or when the use of ramps results in excessive cut and fill and/or result in excessive visual dominance of the park or open space.
- Shorter stepped routes of higher gradient are preferable to longer ramped routes with a shallower gradient.

Design Parameters - Stairs

- For regulations on accessible gradients and level changes, please refer to the New Zealand Building Code, Clause D1 - Access Routes.
- Bicycle wheeling ramps should be installed on all new paths with stairs and where practical, retrofitted onto existing stairs - Specifications for these are:
 - Gradient should not exceed 1:4 (25%)
 - Ramp should be min 0.4m from any wall or obstacle to avoid pedal and handle clashes
 - Consider a wheel ramp on both sides of the stairs where volumes are high
 - Transition at top and bottom of ramp should be as smooth as possible

Design Parameters - Ramps*

Accessible Pedestrian Routes

- 1:12 acceptable slope - With handrails
- 1:20 acceptable slope - Without handrails
- For every 750mm rise - a 1200mm level landing is to be provided

**For additional information please refer to the New Zealand Building Code, Clause D1 - Access Routes*

Shared Routes

- 1:10 slope is acceptable up to 50m in length where pathway is straight
- 1:6 slope is acceptable for lengths up to 50m where the horizontal path is curved and/or changes alignment
- For every 1500mm rise - a level landing equal or greater than the width of the ramp is to be provided
- For cycling purposes - paths that exceed these parameters are considered extremely hazardous
- The minimum inside radius for hairpin turns on ramps is 2.5m

Tools for Slowing People on Bikes

In situations where long straight and flat or steep paths are unavoidable and where speeds over 20 km/h are likely, curvaceous or indirect alignments, changes in texture and vertical alignment can be introduced to slow people on bikes. In instances where this is not possible, 4m wide multiuse paths, separated paths or physical protection using balustrades, barriers and fences should be considered.

NOTE: These tools should be used sparingly and should not be introduced to the detriment of a logical alignment of a Local Path for example, the straight alignment along the edge of a sports field or coastline.

Horizontal Alignment

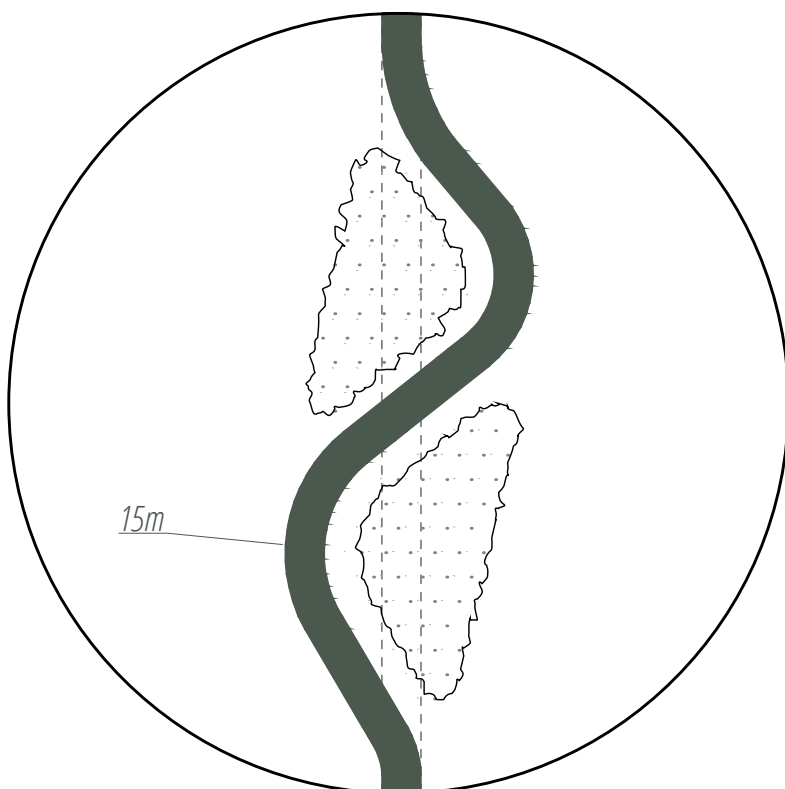

Changes to the horizontal alignment can reduce the speed of a person on a bike. At speeds over 20km/h, curves with a radius smaller than 15m will be experienced as a tight curve, and will require a person on a bike to reduce their speed. Where a significant and localised reduction in speed is required (e.g intersections) a radius smaller than 5m will help to slow a person on a bike to a speed at which will allow them to mix safely with pedestrians and other users without dismounting.

Texture Change

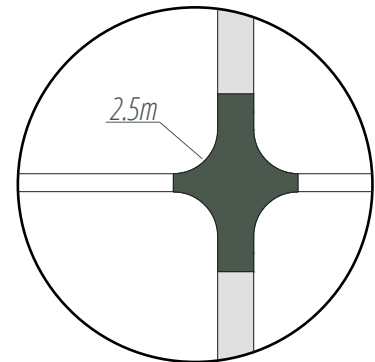

Textural and colour changes can be used to create a contrasting surface that alters the experience of the cycle journey. A heavily textured and/or contrasting surface can be used to alert a person on a bike of an upcoming hazard or draw attention if they are straying off course.

Vertical Alignment

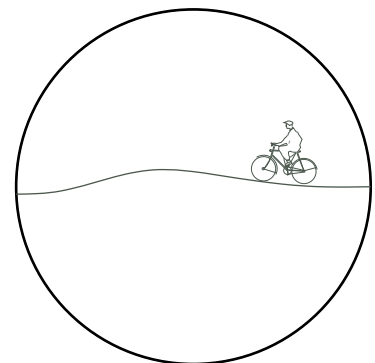

In instances where it is possible to do so with minimal earthworks, lengths of vertical curve can be reduced to 10m or less.

Intersections

An intersection is a junction between Local Paths and/or between a Local Path and one or more paths of another function. The design and layout of intersections is particularly important for the safety of a Local Path. In most intersections in a park or open space, the Local Path will be the widest, and highest priority of the paths. It is important that all users at an intersection are travelling at a speed conducive to eye contact, that clear sight lines are maintained and sufficient space is maintained to allow for safe stopping.

Design Considerations

- Where possible, intersections should be accessible and safe to users of all ages and abilities.
- Intersections should be constructed to preference the predominant flow.
- The dominant path at an intersection should be given prominence through the use of dimension, jointing detailing, form and surface.
- People on bikes should enter the intersection at a speed that allows them to mix safely with pedestrians and other users without dismounting.
- Where advanced warning to an intersection is necessary, tactile linework and/or changes in ground texture is preferable to signage.
- Intersections should be free of obstructions and where possible be free of road markings and 'Advanced Warning Signage'.
- Utilise hard and soft landscaping to reduce "corner cutting".
- Where appropriate, consideration should be given to the incorporation of way finding signage, infrastructure such as a drinking fountain, landscape features and/or 'Place Based Signage'.
- Landscape features that are intended to be vegetated should be a minimum of 10m² and be no narrower than 500mm. At 10m² vegetation should be limited to groundcovers and small shrubs. Landscape features over 100m² can accommodate larger specimen trees.
- Where practical, utilize the spaces formed between paths at intersections for WSD and/or landscaping.

Cost ● ● ● ● ●

See page 125 - 133 for more information

Opportunities for Up cycling

A wide range of recycled materials can be incorporated into pavements at intersections to provide 'advanced warning' indicators.

Design Parameters

- Intersection design and layout should conform to minimum sight lines relative to design speed. Typical minimum sight line distance is 20m. See Safe Stopping Distances for Cyclists page 17 for more detail.
- Where possible, the inside radius of a Local Path at an intersection should be a minimum of 5m.
- At hairpin turns and corners greater than 90 degrees where a 5m minimum inside radius is not achievable .
- For all pedestrian pathways entering the Local Path, the inside radius should be a minimum of 2.5m to allow for cycle manoeuvring without dismantling.

Common Intersections

The "T", "Y" and "X" intersection configurations are most common within parks, although there are very wide variations on these basic themes. In most cases a 'T' intersection is preferred followed by a 'Y' intersection. Crossroads and 'X' intersections should be avoided as they increase the risk of high speed collisions. Where crossroads and 'X' intersections are unavoidable, special consideration should be given to slowing approaching cyclists.

T' Intersection

Y' Intersection

X' Intersection

Standard

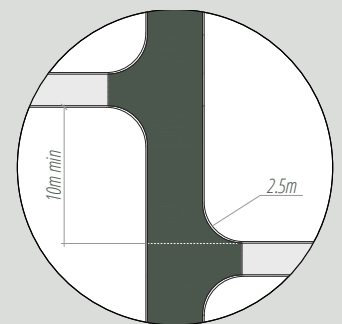
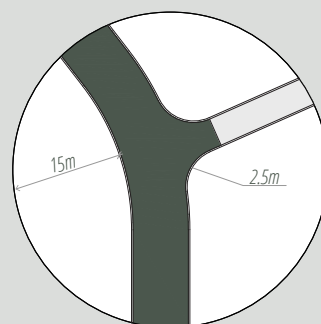
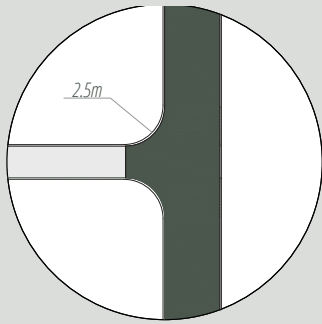

Common Variation

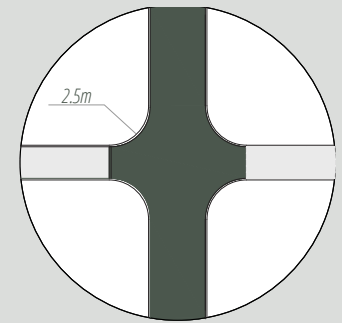
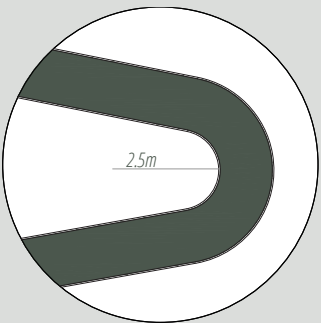
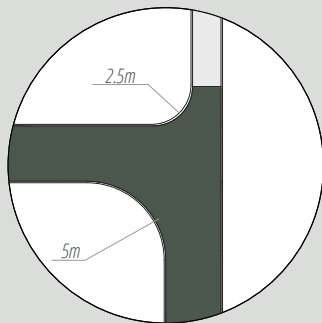

Island Inclusion

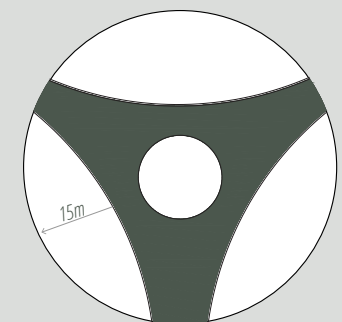
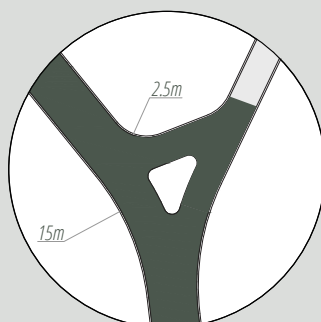
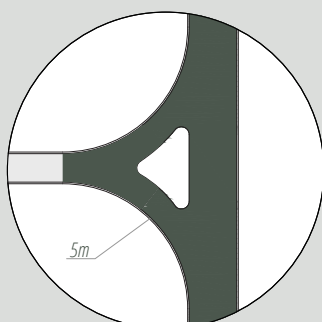

Impermeable Surfaces

The surface treatment of the path helps to determine the accessibility, safety, comfort and experience of the Local Path. It is also the key factor determining the durability, life expectancy and maintenance requirements of the Local Path. For these reasons, the preferred material for a Local Path through a park or open space is a lightly exposed aggregate of 10mm basalt with a small amount of black oxide to reduce glare. This preferred path is recognisable across Auckland and ties in well with many of Auckland's existing footpaths and paved surfaces. It is long lasting and suitable for high traffic volumes. It has very good slip resistance, is not glary at implementation and utilises regionally sourced aggregates. In many cases there will be good reason to veer away from this standard in order to incorporate additional or alternative materials such as locally sourced and/or recycled aggregates.

Design Considerations

- The surface treatment of paths should reflect the anticipated volumes of traffic - In higher volume areas, more durable surfaces will be required.
- Where appropriate, the surface treatment could incorporate placed based or up-cycled aggregates and oxides. In these instances, designers will need to consider the implications of maintenance, life expectancy, slip resistance and glare (if any).

Design Parameters

- The slip resistance of all Local Paths paths should have a minimum friction coefficient of 0.4.
- Surfaces constructed to match existing features must have a maximum tolerance of 5mm.

Opportunities for Placemaking

In many locations it may be appropriate to include additional or different aggregates and/or oxides to reference and reflect the local environment. For example Local Paths in coastal locations could include shell and/or sand in the path, where a Local Path along the margin or at the mouth of a river might include river pebbles or aggregates in Volcanic fields and lava flows.

Opportunities for Up cycling

In many locations it may be appropriate and/or the opportunity might present itself to include additional recycled aggregates and/or oxides to reference and reflect the local community and/or take advantage of a readily available recycled material. For example, crushed bricks could be included in Local Paths in and around New Lynn.

Outline Specification

Concrete Paths

- Insitu concrete pavement. 10mm basalt chip mix. Mid grey (6% Oxide) matrix. Lightly exposed aggregate or brushed finish. To be installed over a compacted base and subbase.
- Provide edge thickening to all pavement edges. Allow for saw cuts and construction joints as required by engineer. For cycle path purposes use only cut joints at a minimum width specified by the engineer. If troweled or formed joints are required, sealing of the joint may be necessary to provide a smooth junction.
- Avoid long wave corrugations. Float using a large (4m) bull float where applicable.
- Construct new concrete to match existing feature e.g. a catchpit, to 5mm tolerances.
- Engineer to provide concrete strength and reinforcing detail.
- Allow for vehicular loading where applicable.
- For repairs - whole panels should be replaced (from expansion joint to expansion joint).

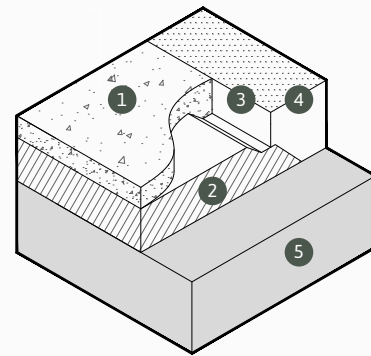

Key

- ① Concrete Surface
- ② Compacted Base / Base Course
- ③ Constructed Edge Recommended
- ④ Adjacent Ground
- ⑤ Compacted Sub Base

Cost ●●●○

Place-based Materials

- Coastal - Shell, Pebble and other marine based inclusions
 - Volcanic - Aggregates
 - Riverside - Pebble

Cost ●●●●●

Up cycled Materials

- Brick
- Glass
- Fly Ash

Cost ●●●●●



Exposed Aggregate



Brushed Finish

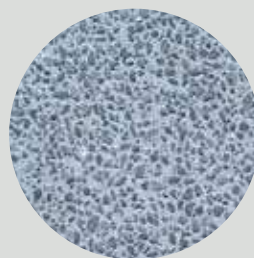

Place Based - Pebble



Place Based - Shell

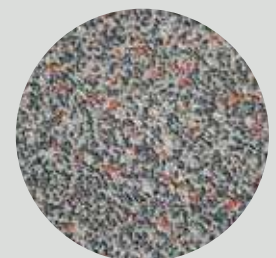

Up cycle - Glass

Permeable Surfaces

There is a wide variety of bound permeable paths suitable for a Local Path through a park or open space. Variations include bound gravel; permeable concrete; permeable unit paving; crushed concrete or brick; resin bound aggregates; hoggin, which is a mixture of clay, gravel and sand; Aggrock, a proprietary stabilised aggregate with a similar look and feel to hoggin; or rubber matting infilled with pebbles. Permeable paths, while not as durable as impermeable paths, have a range of benefits including reduced initial cost, site specific applications around tree roots and the opportunity to provide a unique look, feel and user experience.

Design Considerations

- The surface treatment of paths should reflect the anticipated volumes of traffic - In higher volume areas, more durable surfaces will be required.
- Allow for vehicular loading where applicable.
- Where appropriate, the surface treatment should incorporate place-based or up-cycled aggregates and oxides. In these instances, designers will need to consider the implications of maintenance, life expectancy, slip resistance and glare (if any).
- Carefully consider the need for edging. In many instances edging is needed to hold the pathway together and for ease of maintenance of plants growing into the Local Path. However in some cases, edging can concentrate water flows and erode the path, increasing maintenance requirements and creating a trip hazard. Therefore:
 - Edging should be used in situations where a formal, 'tidy edge' is required, such as in suburban, manicured, open park land settings.
 - No edging is required in natural / bush settings where maintenance issues are less of a concern.
- Permeable paths provide a solution for installing a pathway under the canopy or over the roots of an existing tree - See also, Bridges and Boardwalks Below.
- Bound or loose material paths should not be used where there is risk of erosion due to the steepness of the path or run-off from adjacent sites.

Opportunities for Up cycling

Refer to Impermeable Surfaces (pg 64)

Design Parameters

- The slip resistance of all Local Paths paths should have a minimum friction coefficient of 0.4.
- Surfaces constructed to match existing features must have a maximum tolerance of 5mm.

Over Tree Roots

- Permeable path options can provide a solution for installing a pathway under the canopy or over the roots of an existing tree without detrimental effects to that tree.
- For pathways over tree roots a "No dig" solution must be employed. A no dig solution may require engineering input to establish a means to stabilise the existing ground so that a path may be built up on top of the existing ground.
- No compaction should occur in the vicinity of trees.

Outline Specifications

For All Paths

- Permeable weed mat geotextile is recommended below path layer to prevent weed growth through the pathway. Provision for this at path installation will reduce the requirement for the ongoing/regular use of chemical sprays to maintain the path.

Hoggin / Aggrock

- 20% cement inclusion to the hoggin / aggrock mix will provide for a more stable finished path.
- 10 - 30% road chip inclusion will reduce the impacts of glare from white hoggin products.

Key

- 1 Hoggin / Aggrock
- 2 Base Course
- 3 Constructed Edge
- 4 Adjacent Ground
- 5 Weed Matt
- 6 Compacted Sub Base

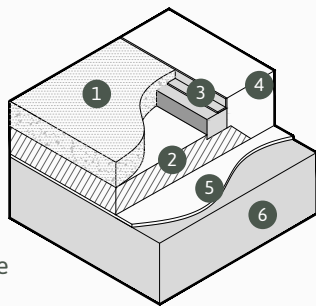

Cost ●●○○○

Permeable Pavements / Permeable Concrete / Permeable Unit Pavers

- A 50mm - 100mm layer of select permeable pavement mix or permeable paving units, to be poured/placed atop a compacted base and subbase. Base preparation to engineer specification.
- For permeable paving - method for binding the aggregate is by a resin layer applied to the mix in place, or cement binding in a no fines concrete mix.
- For permeable concrete - finishing of surface should be tempered flat in a manner that reduces screed marks left on the finished surface.
- For permeable paving units - A sand layer will be required atop the compacted base to level the pavers. Once installed the permeable pavers can be back filled with loose aggregate material or soil/grass seed.

Key

- 1 Permeable Surface
- 2 Base Course
- 3 Constructed Edge
- 4 Adjacent Ground
- 5 Weed Matt
- 6 Compacted Sub Base

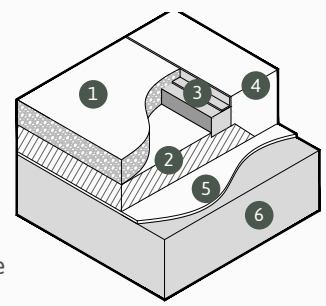

Cost ●●●●○

Bound Gravel / Block Pavers

- 75 - 150mm layer of self binding aggregate rolled or compacted. Optimum aggregate surface for cycles can be achieved using compacted quarry dust (Grade) aggregates. Compacted quarry dust offers a more uniform and smooth riding surface compared with larger aggregates. Any aggregate selection to be placed over a compacted base and subbase to engineer specification.

Key

- 1 Aggregate Surface
- 2 Base Course
- 3 Constructed Edge
- 4 Adjacent Ground
- 5 Weed Matt
- 6 Compacted Sub Base

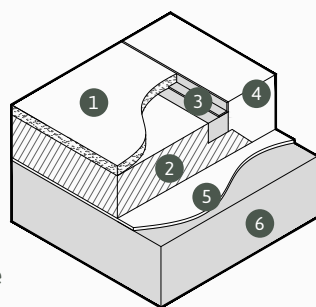

Cost ●○○○○

Pebble Filled Matt

- Rubber/cellular matting products may be used to stabilise a number of surfaces. Most commonly they are used to stabilise grass or loose pebble/aggregate surfaces.
- A suitable rubber/cellular matting should be installed over a compacted base and subbase. Base preparation to engineer specification. Matting should be securely pinned down to base using an approved supplier method.
- Selection of a pebble / aggregate fill should consider the size of the apertures in the matting. Selection should be made for a pebble / aggregate that will sit stable within the apertures of the matting and not migrate upwards (out) or downwards (through) the matting layer.

Key

- 1 Rubber Matt
- 2 Base Course
- 3 Constructed Edge
- 4 Adjacent Ground
- 5 Weed Matt
- 6 Compacted Sub Base

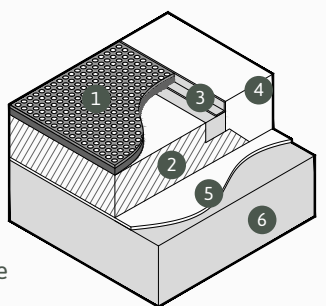

Cost ●●●●●

Bridges and Boardwalks

Bridges and boardwalks are typically associated with natural features such as, coastal environments, streams and wetlands and are often employed to bridge over the roots of trees, or boggy areas. The major considerations for the design of a bridge or boardwalk are the structure, the walking / cycling surface and the edge treatment or balustrade (the later two are addressed in the following sections). The structure is typically either timber or steel. The walking / cycling surface is typically timber but can be concrete or steel. In most cases, a timber structure and surface is the most appropriate, value for money approach.

Careful consideration needs to be given to the accessibility and safety of the boardwalk surface, particularly with regards to the level of slip resistance.

Design Considerations

- The size of foundations and associated excavation should be minimised.
- The structural elements of the bridge or boardwalk should minimise the use of materials.
- The design and layout of the bridge or boardwalk should avoid the need for vehicles to cross.
- A Slip resistant surface must be maintained on all boardwalks. Timber can become slippery when wet and should be avoided if possible. In some cases, additional surface treatments will need to be applied to timber surfaces in wet and/or shaded areas. Strategies for improving slip resistant of the surface include metal inserts, resin sand paint, grip tape, wire mesh.
- Wire mesh used as an anti slip mechanism should be robust enough to cope with cycle use. A thicker gauge mesh is usually required compared with what might be used on a pedestrian only boardwalk. Plastic Mesh should not be used as is susceptible to vandalism.
- Where the use of timber is deemed problematic. Alternative boardwalk surfaces may be considered such as Metal, Concrete or synthetic surfaces (GRP and other surface panels).

Cost ● ● ● ● ●

See page 125 - 133 for more information

Design Parameters

- The slip resistance of all Local Paths paths should have a friction coefficient of 0.25.
- Surfaces constructed to match existing features must have a maximum tolerance of 5mm.

Opportunities for Up cycling

In some cases it may be possible to incorporate recycled timber or steel into the frame, surface, balustrade or edging of a bridge or boardwalk.

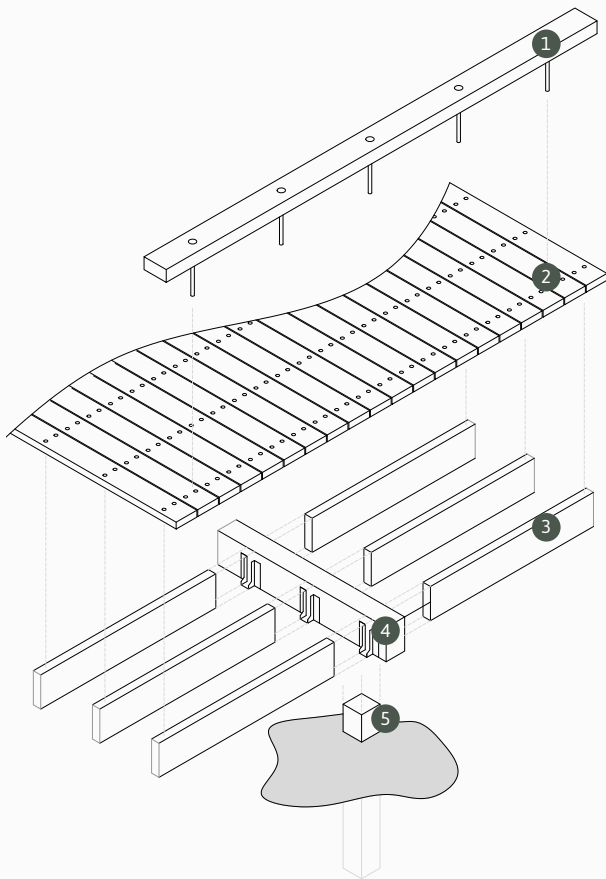

Key

- ① Edging
- ② Deck Surface
- ③ Joists
- ④ Bearing
- ⑤ Piled Footing

Timber Boardwalk

- FSC certified hardwood or H4 treated pine decking boards with an appropriate anti-slip treatment to decks in wet or shaded environments.
- Tamper proof screw fastenings. Fastenings to be countersunk and sized to suit timber dimensions and loadings.
- Planks are to run perpendicular to the line of travel and gaps between boards to be minimum 3mm and maximum 6mm.
- Consider filling large fixing holes with sealant for a nautical “look” in coastal environments.
- Treated timbers need to be considered for the potential risk of chemical leaching into water bodies.
- Additional costs can be incurred to install and maintain non slip surface treatments.
- Demand for structure is reduced due to timber being light weight.

Galvanised Steel

- The strength of steel makes it an ideal selection for where larger spans or slimmer bearing profiles are required.
- A galvanised steel structure has the ability to carry heavy boardwalk surfaces such as precast concrete panels, steel grates or other heavy boardwalk surfaces.
- Consideration is required when proposing galvanised steel in close proximity to coastal environments.
- All galvanised steel structures should be to engineering structural design and specification.

Precast Concrete Panels

- Precast concrete panels used as a boardwalk surface will usually require a steel support structure due to the weight of the panels.
- The precast panel surface can be poured to a finish to meet slip resistance requirements. This reduces the maintenance requirement for the life of the material.

Steel Support Structure

- HDG steel support frames, members, fixing, junctions and strengths to structural engineer specification.
- Allow for vehicular loading where applicable.

Timber Support Structure

- H5 treated sub structure with 316 stainless steel hardware. Piled footings. All to NZS:3604 specification and detail.
- Refer to an engineer for timber detailing outside the scope of NZS:3604.
- Allow for vehicular loading where applicable.

Boardwalk Edges

- Where no significant fall from height exists - Consider an upstand at boardwalk edges to prevent wheels leaving the boardwalk extents.
- For this purpose a min 75mm high x 100mm wide upstand should be provided.
- Material choice to consider boardwalk design, strength and loadings.
- Stainless steel tamper proof fixings to be countersunk and sized to suit material thickness, span and loadings.
- Consider filling large fixing holes with sealant for a nautical “look” in coastal environments.

Edge Treatments

Edge treatments refers to the outside edges of a Local Path. In most instances, edging is only required when a path is constructed from a bound permeable surface. In some situations, it may be desirable to include an edging to a path of impervious surfaces however this would typically be included as an amenity or place based feature. Edging can be constructed from timber, concrete or steel. Steel edging may be of galvanized steel, stainless or aluminium.

Design Considerations

- The edging of a Local Path should contain the material of the path as effectively as possible.
- The edging of a Local Path should allow for mowing and other landscape maintenance activities.
- In most instances, the edging of a Local Path should be flush with the path and adjacent surfaces.
- Where appropriate, consideration could be given to increasing the width and prominence of the edge of the path to increase the unique qualities of the site, park or open space.

Timber

- 25 x 150mm hardwood or H5 pine timber board. Fixed using 316 Stainless steel screws to timber support stakes. H5 pine timber support stakes to be driven into good ground to provide fixing for edging boards. Support stakes to be provided at nominal 600mm centres along the length of any timber edging board.
- Adjacent surfaces should be compacted flush with edge at time of construction to avoid differential in levels over time through settling.

Key

- ① Timber Edge
- ② Timber Stake
- ③ Path
- ④ Adjacent ground
- ⑤ Compacted Sub Base

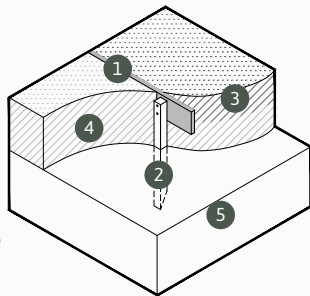

Cost ● ○ ○ ○ ○

Steel

- 60mm equal angle metal edging. In general edging and fixings should be the same material. Where this is not possible consider metal indifferences when selecting metal edgings and fixings.
- For light traffic areas metal edging may be staked in place using metal spiral stakes driven into good ground.
- For high traffic areas, metal edgings may need to be fixed to an underground concrete haunching.
- Round off the top of exposed surfaces of all metal edgings flush with adjacent surfaces.
- Adjacent surfaces should be compacted flush with edge at time of construction to avoid differential in levels over time through settling.

Key

- ① Steel Edge
- ② Concrete Haunching
- ③ Path
- ④ Base Course
- ⑤ Adjacent ground
- ⑥ Compacted Sub Base

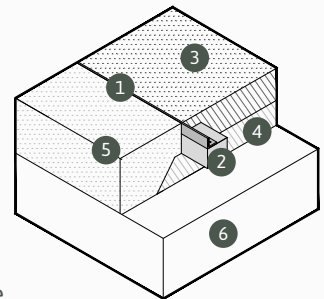

Cost ● ● ● ● ● ○

Concrete

- 100mm - 300mm wide x 200mm insitu boxed concrete edging. Smooth troweled finish to all exposed surfaces. Minimal radius adjacent to flush surfaces to maintain clean lines between materials. 10mm Radius to exposed edges where damage from vehicles may occur. Reinforcing, expansion joints and construction joints as required by engineer.
- Adjacent surfaces should be compacted flush with edge at time of construction to avoid differential in levels over time through settling.

Key

- ① Concrete Edge
- ② Base Course
- ③ Path
- ④ Adjacent ground
- ⑤ Compacted Sub Base

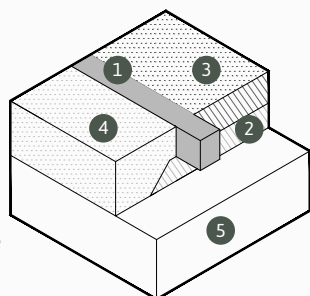

Cost ● ● ● ● ● ○

Balustrades, Barriers & Fences

A balustrade or a barrier refers to any vertical element designed to keep people within the Local Path and are primarily employed for the safety of the users. A balustrade is typically 1.4m tall and is designed to restrict the fall from height risk. A barrier is lower than a balustrade and is typically employed when the risk to injury resulting from a fall is minor. A barrier can be either constructed or planted. A fence is typically employed to either keep people out of the Local Path or to prevent other activities from spilling into the Local Path, such as a ball from an adjacent sports field. Balustrades and barriers are designed so that people on bikes may brush against the barrier without getting clothing or bike parts caught or snagged in the structure, a fence is typically not designed with this function in mind.

Design Considerations

- Ensure that the balustrade, barrier or fence is being employed for the appropriate function - see Required Use.
- The choice of material and planting should be appropriate to the context - for example a fence should be visually permeable and planting low lying where passive surveillance is required.
- In constrained sites, path widths may need to be reduced to allow for the balustrade, barrier or fence.
- In most instance, a planted barrier is preferred to a balustrade, fence or constructed barrier.
- Where the use of a balustrade, fence or constructed barrier is required, a planted barrier may be included to soften the visual appearance of the the balustrade, fence or constructed barrier.
- Maintenance requirements of plants needs to be considered carefully. If there is a risk that maintenance is going to be sporadic then low maintenance native plants are recommended.
- Ensure that the character of the planting considers the specific types and character of planting in the park or open space.

Species Suggestions

Some species appropriate for a vegetated barrier include but may not be limited to:

- *Alectryon excelsus*
- *Aristolelia serrata*
- *Carpodetus serratus*
- *Coprosma* spp.
- *Cordyline australis*
- *Hebe* spp.
- *Hoheria populnea*
- *Kunzea ericoides*
- *Leptospermum* spp.
- *Macropiper excelsum*
- *Melicytus ramiflorus*
- *Myrsine australis*
- *Phormium tenax*
- *Pittosporum* spp.
- *Pseudopanax lessonii*
- *Sophora microphylla*

Low lying plants for areas where site lines need to be maintained:

- *Apodasmia similis*
- *Arthropodium cirratum*
- *Carex* spp.
- *Libertia grandiflora*
- *Muehlenbeckia astonii*
- *Phormium 'Green Dwarf'*

Utilise eco-sourced species from within the same district where possible.



Phormium tenax



Pittosporum spp.



Muehlenbeckia astonii



Carex spp.



Libertia grandiflora

Balustrades

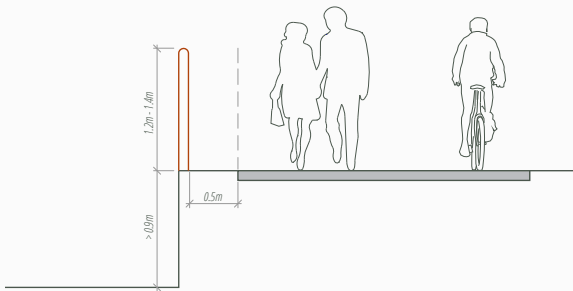

Outline Specifications

- A balustrade is typically constructed from steel, timber and/or glass.
- A balustrade is to be used when the fall risk is larger than 0.9m.
- The recommended height for a balustrade is 1.4m. The minimum height is 1.2m.
- The maximum gap between balustrades is 0.1m for where young children are expected to be unsupervised.

Cost ●●●●●

Barriers

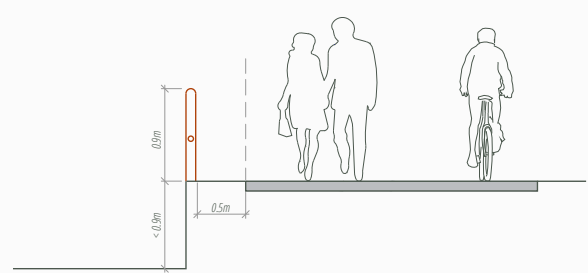

Outline Specifications

- A barrier is typically constructed from timber and/or steel.
- A barrier is to be used when the fall risk is less than 0.9m or if another type of hazard such as water or slope occurs within 5m of the Local Path.
- A barrier must be a minimum of 0.9m tall.

Cost ●●●●○

Fences

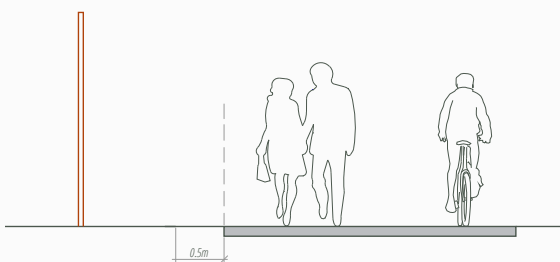

Outline Specifications

- A fence may be constructed of timber and/or steel.
- In most cases, fences should be visually transparent and be difficult to climb.

Cost ●●●●●

Vegetated Barriers

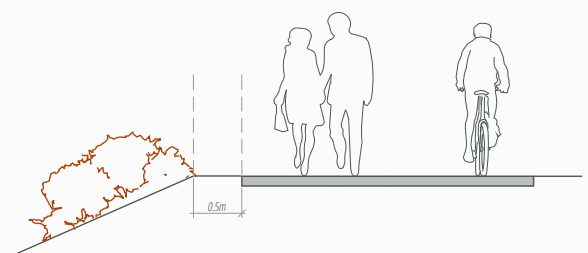

Outline Specifications

- A vegetated barrier can be employed where the risk of fall is less than 0.3m or a slope or batter greater than 1:2 (50%).
- Utilise low lying ground covers along the edges of the path.
- Vegetated barriers are ideally 0.8m tall and should not be taller than 1.2m.

Cost ●●○○○

Lighting and Furniture

Lighting is important to the safety and placemaking qualities of a Local Path. Lighting is described using a 'P' rating which measures the horizontal and vertical illumination of an environment. Horizontal illumination allows users to identify and avoid potholes and obstacles, follow the path, and read surface markings. Vertical illumination allows users to identify features such as fences, walls, kerbs, trees and shrubs. The culmination of horizontal and vertical illumination reduces the effect of shadowing at night. In most instances, a park or open space is required to be lit to a level of either P02 or P03. Special consideration needs to be given to whether or not a Local Path should be lit at night. Lighting at night should be provided when the Local Path is used regularly by commuters after hours, if no other lit path exists and/or if the use of the path is adversely affected by not having lighting. Lighting should not be implemented on Local Paths that are infrequently used or are significantly isolated from adjacent uses meaning there are few or no 'eyes on the Local Path'.

Design Considerations

- The level of lighting provided must be appropriate to the required function - see design parameters.
- Lighting and lighting columns can be used as a wayfinding element during the night and day.
- Local Paths should be future proofed for lighting, even if lighting is not intended in the first instance by either installing ducting at the time of implementation or by allocating space on either side of the path.
- Where appropriate, consideration should be given to the incorporation of lighting with placemaking at entry and exit points and at intersections.
- In places with dense tree coverage, a combination of lighting columns with dual fixtures might be considered.

Cost ● ● ● ● ●

See page 125 - 133 for more information

Design Parameters

- Preferred lighting levels - A P2 standard of lighting is the preferred lighting level for a Local Path that is lit at night*.
- Minimum lighting levels - A P3 standard of lighting is the Minimum lighting level for a Local Path that is lit at night*.
- Where a minimum P3 lighting standard cannot be achieved or is beyond the budget of any particular project - The Local Path should not be lit at night.

** For further information on how to comply with a P2 and P3 standard of lighting refer the Australia / New Zealand Standard on exterior lighting - AS/NZS 1158.*

Internal Park Road Crossing

An internal park road crossing occurs when a Local Path crosses a road within a park. The purpose of an internal park road crossing is to reduce the vehicle approach speed and provide a safe and visibly prominent crossing location for people on bikes and pedestrians. An internal park road crossing can be a flush painted or textured strip or a raised crossing.

An internal park road crossing are crossing points where pedestrians and people on bikes do not have legal right of way, but they do highlight a good place for pedestrians to cross. This means that the treatment will (in theory) make it slightly easier for pedestrians to cross, however, there is no formal requirement for vehicles to give way to pedestrians.

In situations where vehicle access needs to be restricted, features from the entries and exits (page 52) should be incorporated into the design and arrangement of internal park road crossing.

Cost ● ● ● ● ●

See page 125 - 133 for more information

Design Considerations

- The crossing should be raised to the height of the Local Path. Where is not possible, the transition between materials along the Local Path should be flush.
- Surface treatments (cobblestones, thermoplastic markings) are recommended to provide tactile feedback to drivers, people on bikes and pedestrians.
- The ramp approach for vehicles should be a maximum of 1:10 to ensure vehicles don't 'bottom out'.
- Raised crossings may require additional changes to stormwater systems, which can be costly.
- Vehicles and people on bikes should approach the crossing at a speed that allows them to mix safely with pedestrians and other users.
- Where advanced warning to an intersection is necessary, tactile linework and/or changes in ground texture is preferable to signage.

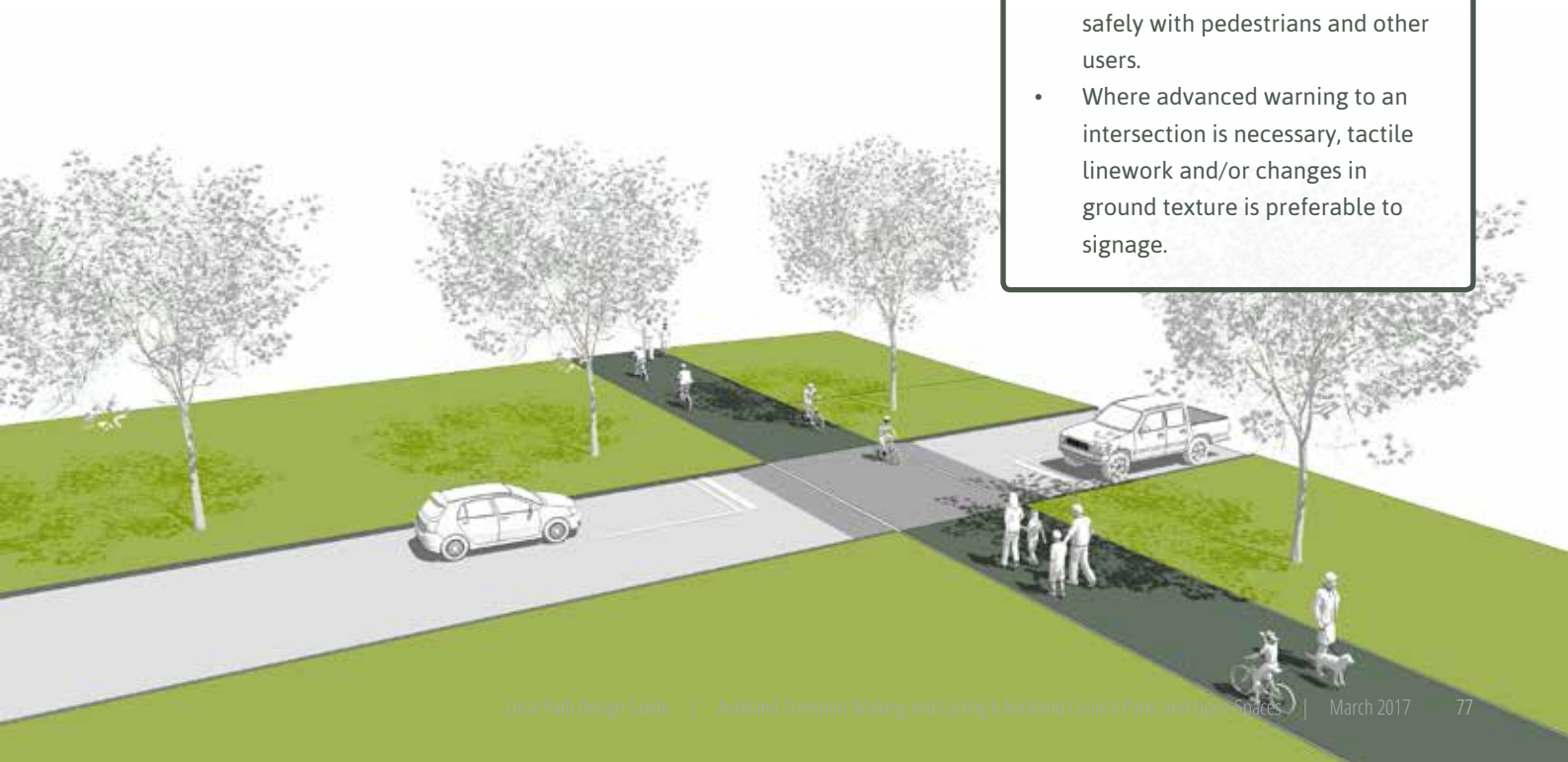

3.3

TOOLS TO REDUCE TRAFFIC VOLUME

Local Paths should be designed, built and maintained for a maximum average of 2,000 vehicles a day.

Minimising traffic volumes of streets and the corresponding exposure of pedestrians and people on bikes to motorised vehicles is critical to a safe and attractive Local Path. Tools to reduce traffic volume take the form of constructed barriers that limit automobile traffic access onto a Local Path route from the major cross-street, and are typically located at major cross streets. They should permit access by people walking and biking, and where required, they must accommodate the access needs of emergency response vehicles.

Diagonal Diverter

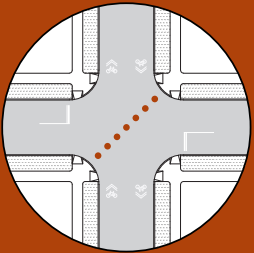
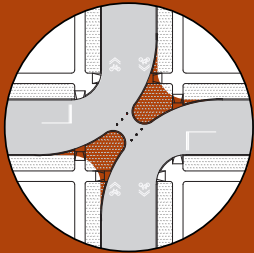

Median Barrier

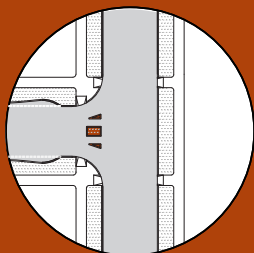
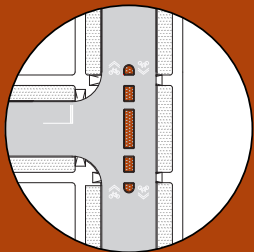
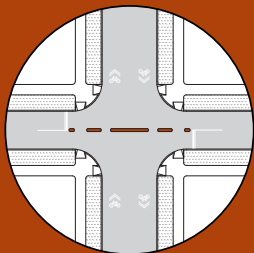
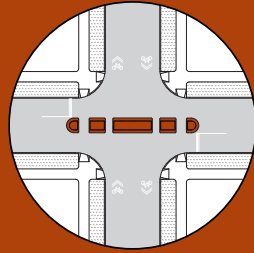

Kerb Extension
Semi-diverter

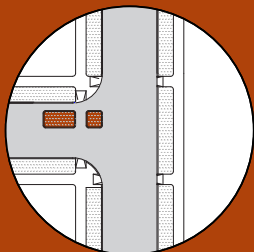
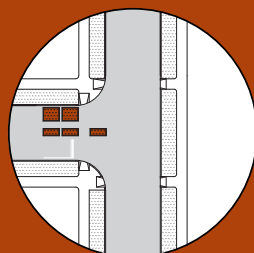
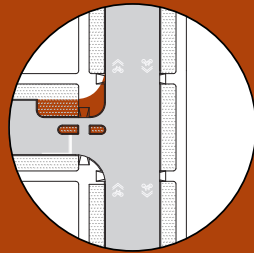

Vehicle Road Closure

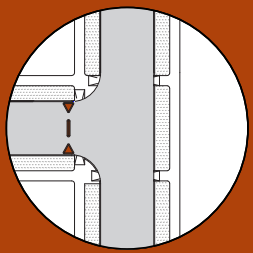
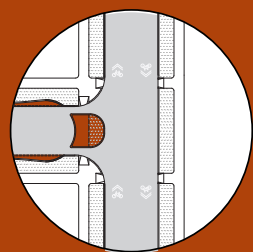
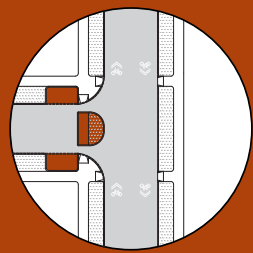
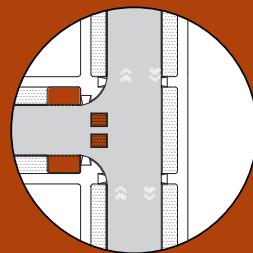

Diagonal Diverter

A diagonal diverter breaks a standard four-way intersection into two opposing left- or right-turn corners. The diagonal diverter can be accomplished with full kerb and sidewalk connections, though small islands are also possible. Bicycle access is enabled via a split in the centre of the intersection and via widened ramps at the former corners. Pedestrian pathways remain the same. Stop signs are frequently used at all approaches, since people biking may proceed after stopping and come out from behind vegetation.

The achieved reduction in vehicle traffic is greatly impacted by the character of the side streets.

Cost ● ● ● ● ●

See page 125 - 133 for more information

Recommended Usage

- In locations with sufficient access options in the street network

Design Considerations

- Street network access, including analysis of the impacts of diverted traffic.
- May require an alternate emergency response route.
- May impact street maintenance.
- Provides good opportunity for landscaping. Native and low maintenance plants are recommended.
- Stormwater runoff/overland flow paths.
- Consider the pedestrian desire for a diagonal crossing and cater for it.

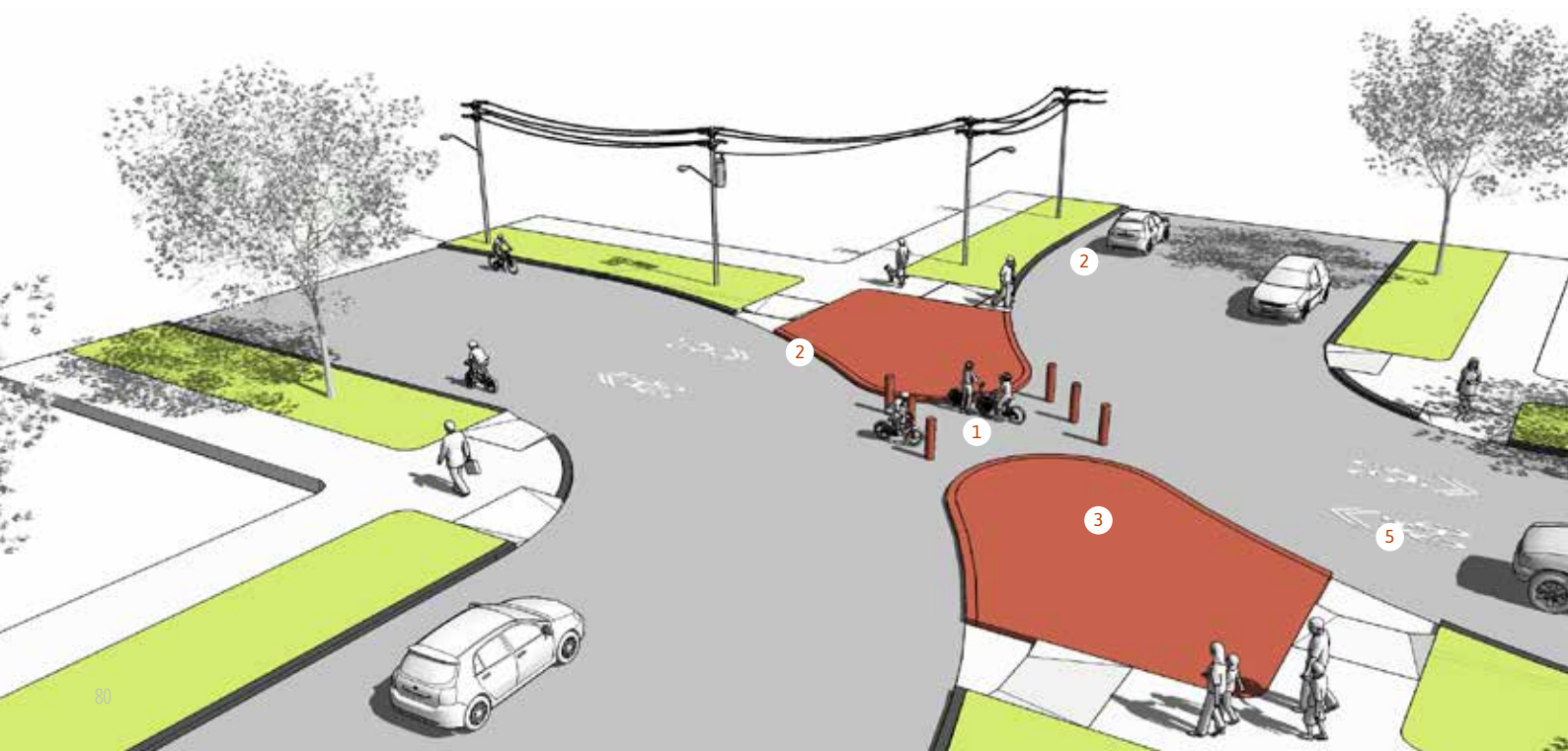

Typical

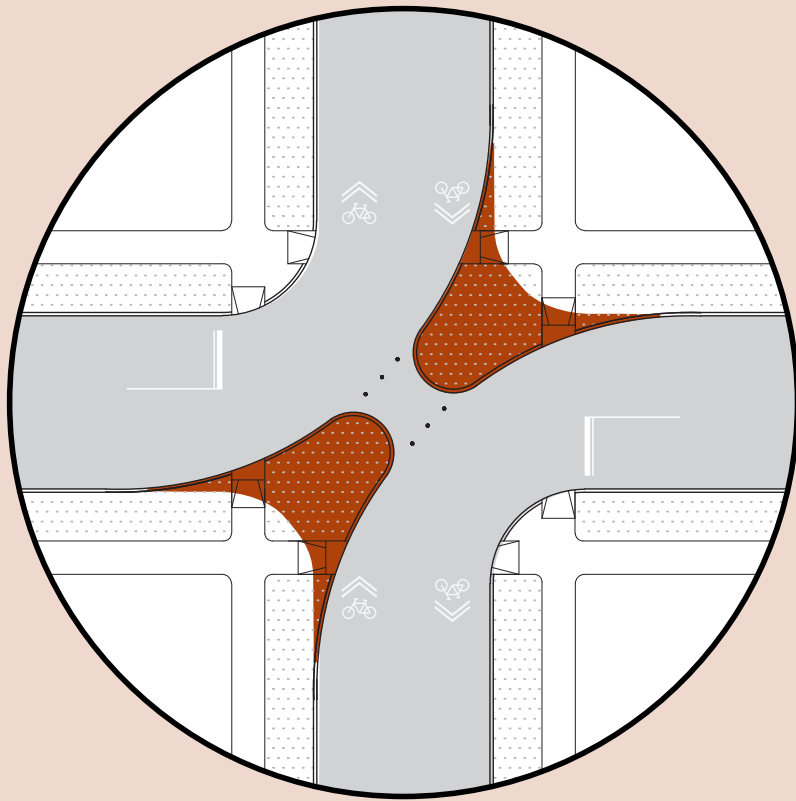

Variations

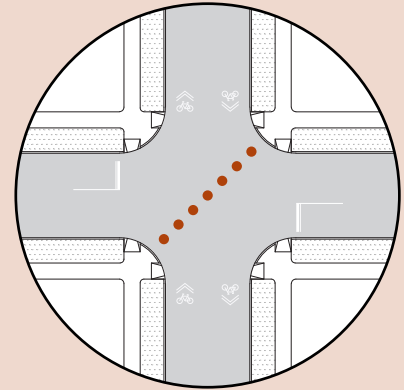

Permeable_ With this low-cost diversion method, the placement of tall planters or bollards is used to prevent all automobile through movement. The crosswalk is inside the planters/bollards, which are spaced 1.2 to 1.5 metres apart. If required, the middle bollard can be movable to provide access to emergency and/or service vehicles.

Design Parameters

- 1 Gaps between bollards should be around 1.5m to provide for bicycles, but not motorised vehicles.
- 2 No parking should be allowed around the central diverter.
- 3 Use reflective pavement markings and signage to increase visibility at night.
- 4 Planting should not obstruct intervisibility and should be <1.0m high in general.
- 5 Sharrow markings may be used for wayfinding and warning purposes.

Median Barrier with Pedestrian and Bicycle Through Route

This island blocks vehicle entry to a street by eliminating right turns from the through street – usually a major cross street - by implementing a raised traffic island. The island also eliminates right turns from the side street, making the side street operate as “left in, left out” only. Gaps are retained for pedestrian and bike access. This allows people on bikes or pedestrians to cross while focusing on one direction of traffic at a time (two-stage crossing). Emergency vehicles gain access to side streets via the opposing lane.

Cost ● ● ● ● ●

See page 125 - 133 for more information

Recommended Usage

- Where a Local Path crosses a collector or minor arterial street.
- On wide roadways with multiple lanes of traffic or few gaps in traffic to allow two-stage crossings.
- Effective when located between signalised intersections, as the signals create gaps between waves of motor vehicles.

Design Considerations

- Street network access, including analysis of the impacts of diverted traffic.
- Emergency vehicle access analysis.
- Opportunities for landscaping with native or low maintenance plants are recommended.
- Street dimensions will need to accommodate for a likely increase in demand for u-turns at the end of the barrier, allow adequate space for turning vehicles.
- Take into consideration potential impact on intersection capacity due to narrower lanes.

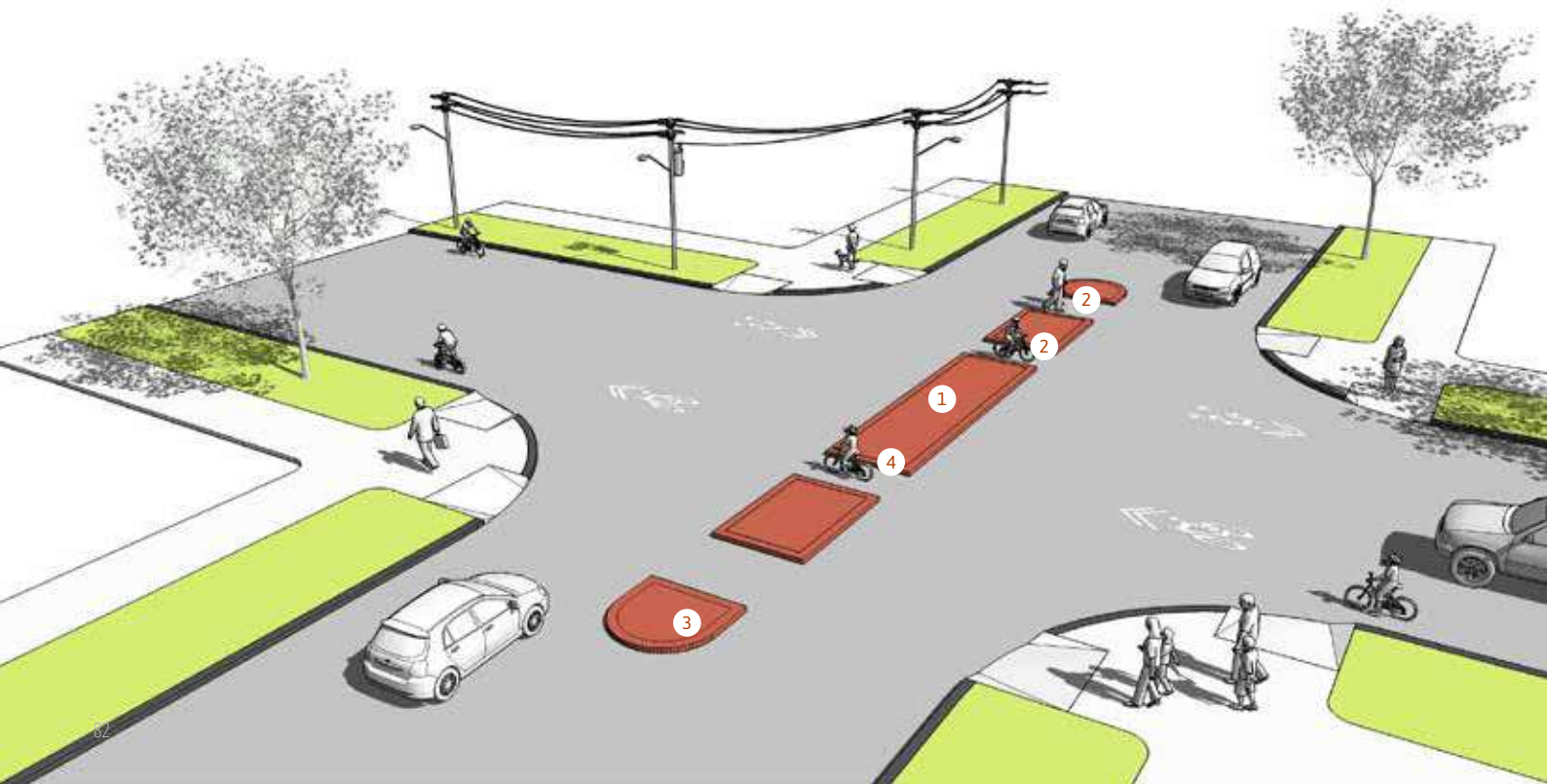

Typical

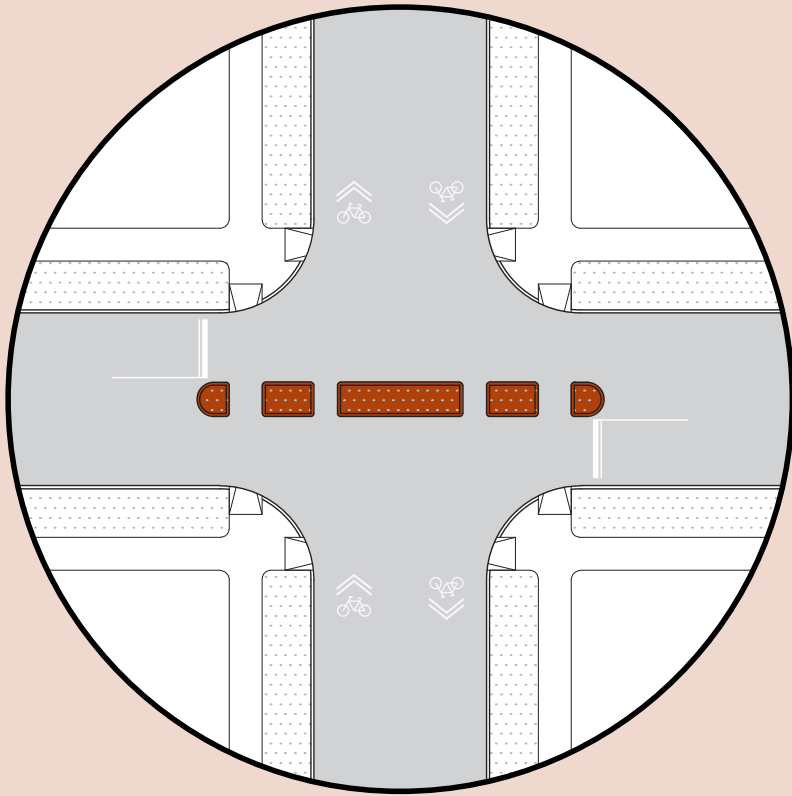

Design Parameters

- 1 Median should be a minimum of 2m wide (2.5m preferable) to provide space for people on bikes.
- 2 Provide separate areas for pedestrian and people on bikes.
- 3 Median island should have 150mm high full kerbs on all sides.
- 4 Install reflectors at the refuge area to facilitate safe crossings at night.

Variations

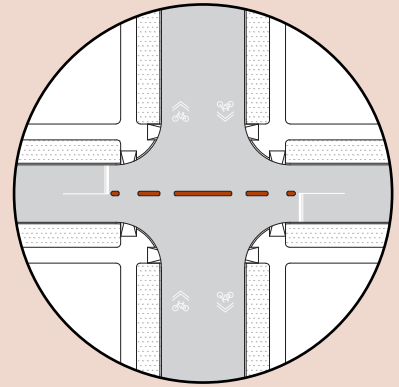

Skinny_ If insufficient space is available, a “skinny” version can be used that still limits tuning movements.

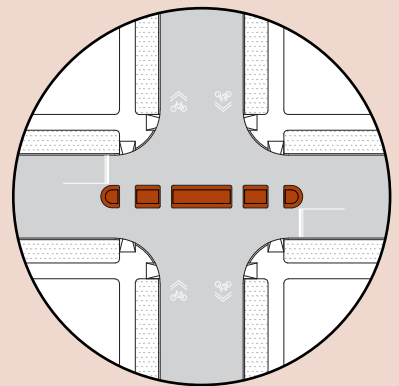

Mountable_ Median can be designed to be mountable by emergency vehicles.

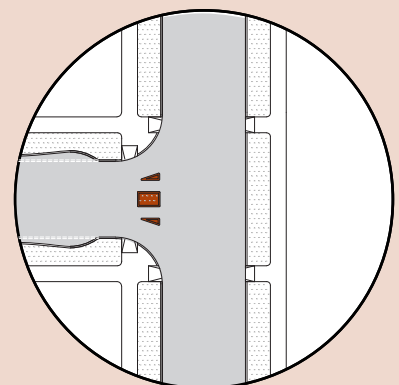

Channelised Left-in/Left-out Island_ This variation restricts through movement for motor vehicles, whilst retaining access to- and from the residences on the block. Through access for people on bikes is provided by the islands, whilst minimizing conflicts with right-turning vehicles.

Kerb Extension with Island Semi-diverter

Kerb extension semi-diverters block vehicle entry to a street by closing off either the inbound or the outbound lane into a street. A traffic island is placed near the centreline with a gap between the island and kerb extension to permit bicycle entry.

It is recommended that the island include vertical delineations to further discourage car use.

Design Considerations

- Street network access, heavy traffic.
- Integration of stormwater infrastructure.
- Pedestrian desire lines.
- Can be combined with a pedestrian crossing to provide additional traffic calming.
- Driveways and access to properties, and the potential loss of on street parking.

Cost ● ● ● ● ○

See page 125 - 133 for more information

Recommended Usage

- A well connected street network is required, so access is retained.
- This tool is compatible with public transport for streets that have uni-directional bus routes (using only one side of the street). Not suitable for streets that have bi-directional bus routes.

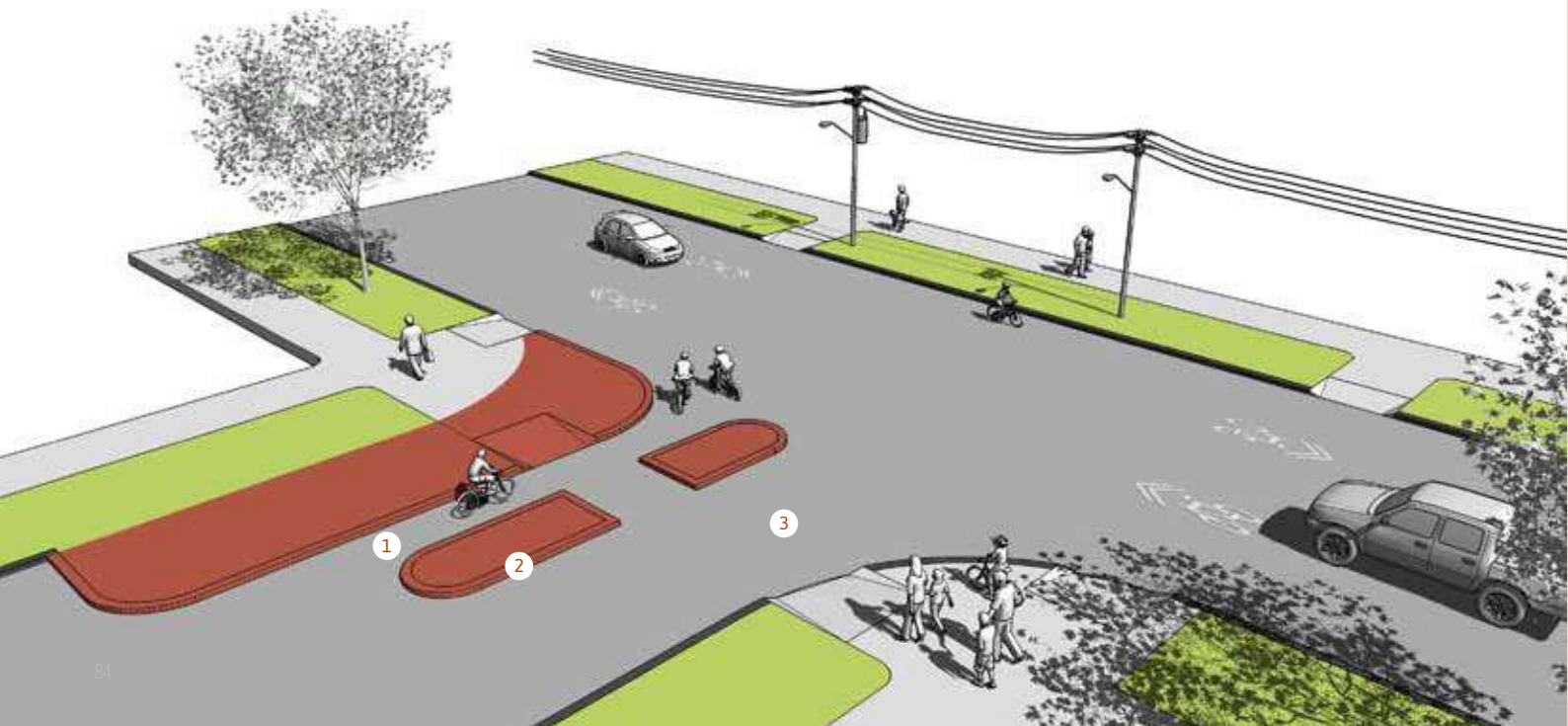

Typical

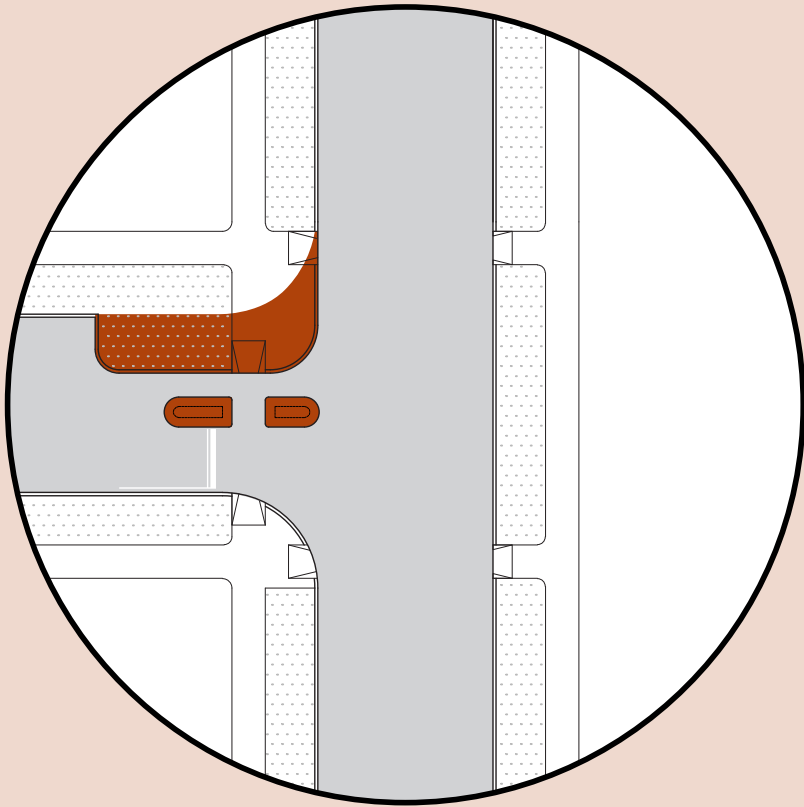

Variations

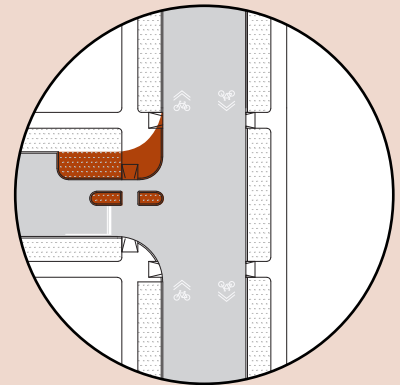

Mountable_ The separator island can be mountable if that would be required for heavy vehicle movements or emergency vehicle access.

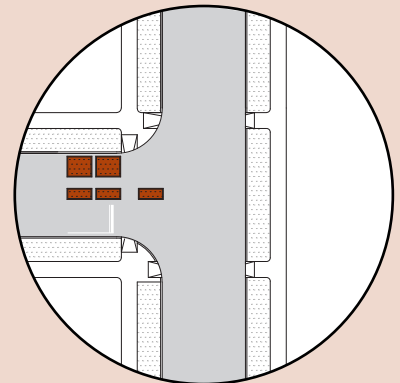

Planter Box_ To test the kerb extension or to save on cost, the separator island can be created using a planter box.

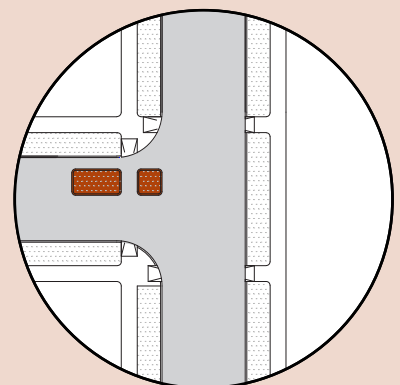

Partial Closure_ Both of these block one travel lane on either side of an intersection, forcing vehicles on both sides of it to turn left or right. A short contra-flow cycleway along the closure allows people on bikes to continue straight ahead.

Design Parameters

- 1 Bicycle cut-through needs to be a minimum of 1.5m wide but less than 2.0m wide to avoid motorised vehicles travelling through.
- 2 Full 150 mm kerb height if the island serves as a pedestrian crossing, otherwise may be mountable.
- 3 A minimum of 3.0m of width should remain available for vehicles entering/exiting the street.

Vehicle Road Closure (Cul-de-sac)

Also referred to as a street closure or diverter. As the name suggests, vehicle road closures close access to a street to all vehicles while maintaining access to bicycles and pedestrians.

Where space is available, providing a turning circle, or cul-de-sac is the most effective solution at reducing motor vehicle traffic volumes along the street. Additionally, a cul-de-sac can be planted to improve the amenity of the street. Special consideration should be given to service vehicles to allow them to turn around in the turning circle provided. Road closures may include ramps with break-away posts to permit emergency vehicle access.

Cost ● ● ● ● ●

See page 125 - 133 for more information

Recommended Usage

- Can only be located on a well-connected street network.
- Typically placed on minor streets at an intersection with a major street, to manage motor vehicle volumes on the minor street.

Design Considerations

- Street network access, including analysis of the impacts of diverted traffic.
- Emergency vehicle access requirements.
- Provides good opportunity for landscaping. Native and low maintenance plants are recommended.
- Existing stormwater catchment pits can generally be retained.

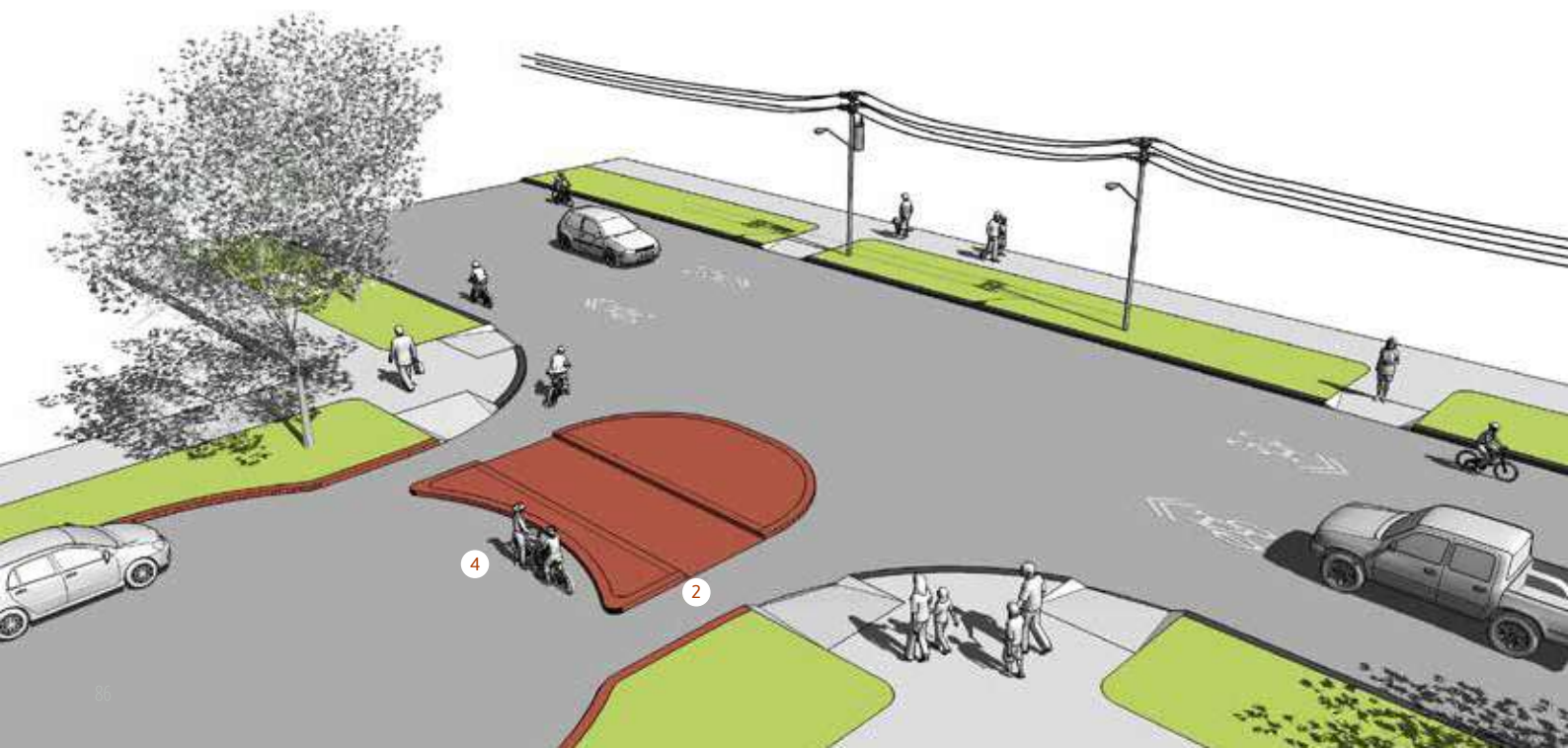

Typical

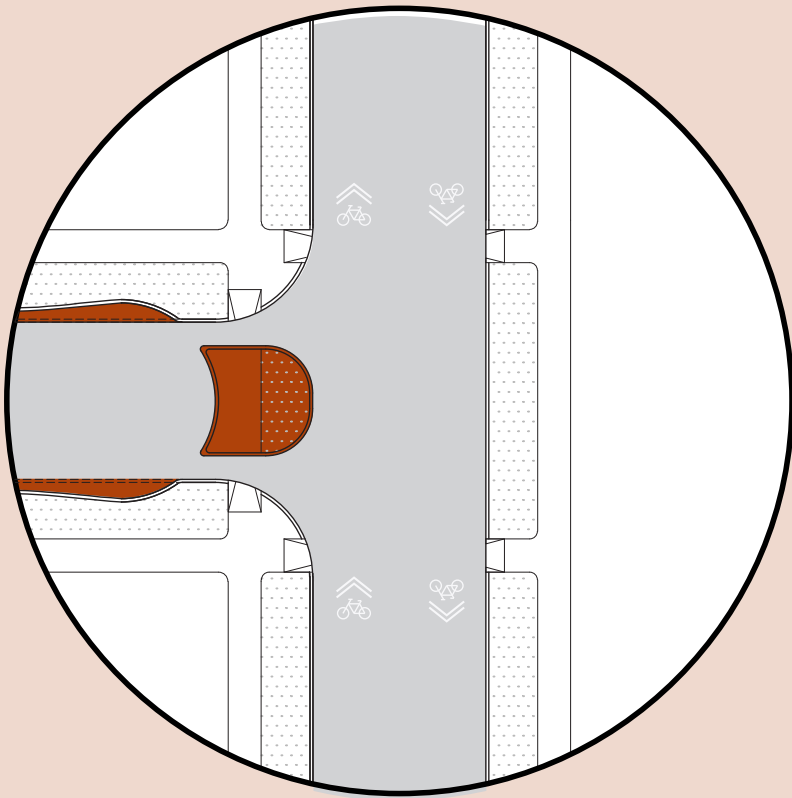

Variations

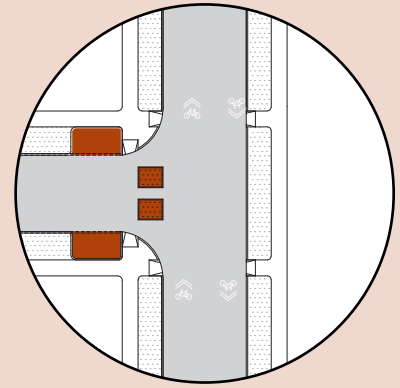

Planter Boxes_ To test the closure or to save on cost, the cul-de-sac can be created using planter boxes.

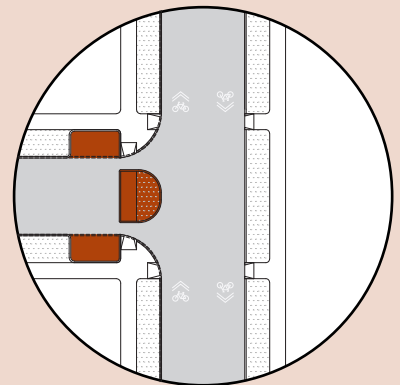

Hammerhead_ As a variation to the cul-de-sac, a hammerhead can be utilised.

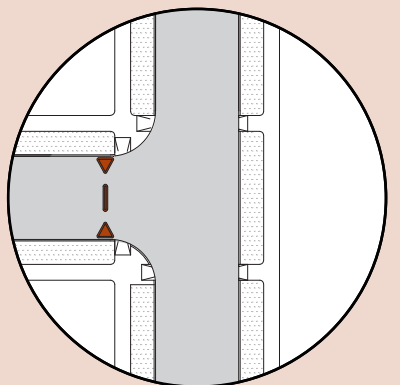

Full Diverters_ The full diverters block motorized vehicles from continuing along a Local Path, whilst a person on a bikes can continue unrestricted.

Design Parameters

- 1 Should include signage indicating people on bikes are allowed to enter the closure.
- 2 Design openings to a minimum of 1.2m in width if not planted, 1.5m if planted.
- 3 Bollards and other barriers intended to prevent motor vehicle access may be hazardous to people on bikes.
- 4 Turning circle should accommodate an 8m truck. Can be achieved using existing vehicle crossings.

3.4

TOOLS TO REDUCE TRAFFIC SPEED

Local Paths should be designed, built and maintained for a vehicle speed of 30kph at most (85th percentile speed).

Slow streets are critical for Local Paths where sharing the roadway between motorised vehicles and people on bikes is expected. As such, setting an upper limit to traffic speeds on streets is an important aspect of a safe and attractive Local Path. Tools for reducing traffic speeds take the form of constructed interventions that restrict the flow of traffic and are typically located mid-block and at intersections of streets.

Mini-roundabout

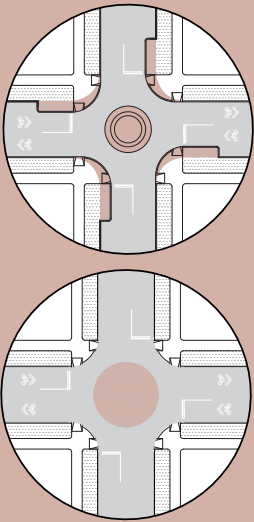

Raised Table

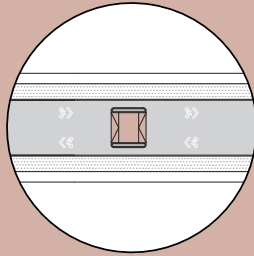

Speed Bump

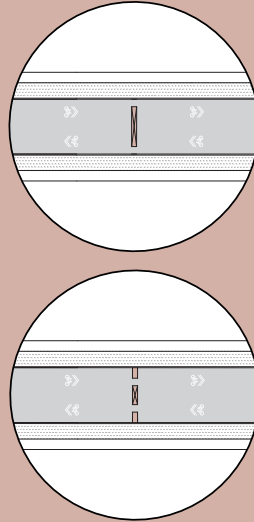

Pinch Point

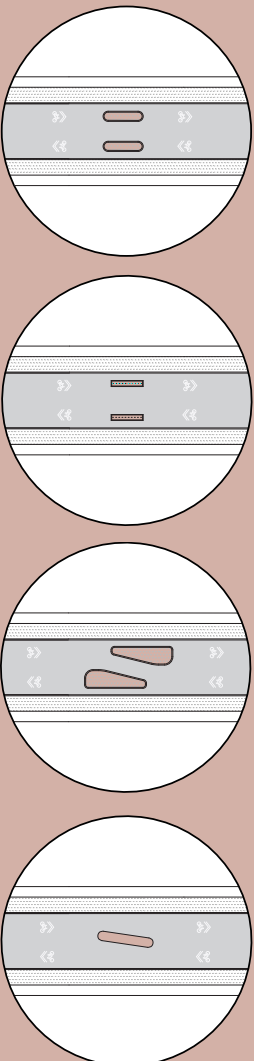

Speed Cushion

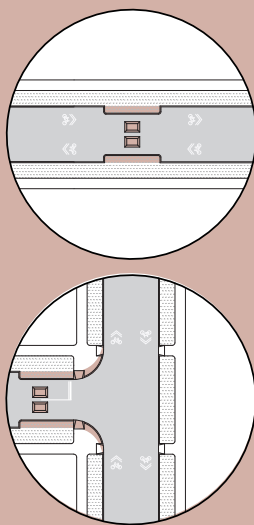

Raised Platform

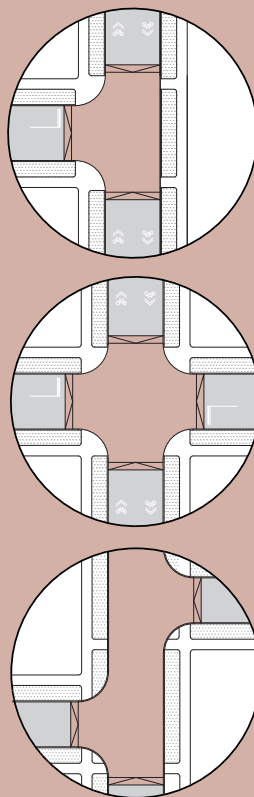

Mini-roundabout

Mini-roundabouts are a tool to reduce speeds and improve safety at busier residential intersections. Mini-roundabouts at minor intersections should use a typical passenger car as the design vehicle, so that speeds are reduced as much as possible. The addition of kerb build-outs on the approaches to the roundabout will further limit approach speeds.

Mini-roundabouts use all the design and operational features of a modern roundabout (deflection, low-speed operation, give-way rules), but do not necessarily have a landscaped centre island. Instead the edge of the centre island can be fully mountable. This permits mini-roundabouts to be used in constrained environments where truck and bus access is to be maintained.

A mini-roundabout is an effective way to deal with intersections that have car movements in all directions as well as a small volume of service vehicles, trucks and even buses.

Cost ● ● ● ● ●

See page 125 - 133 for more information

Recommended Usage

- Use in areas with bicycle and crossing vehicle (flow) conflicts
- This tool is compatible with public transport. On bus routes, painted mini-roundabouts are preferable to those with raised central domes which buses then have to negotiate.

Design Considerations

- Consider including kerb-build outs on each approach to facilitate pedestrians crossing and reduce vehicle speeds.
- If fully mountable, ensure central island is high enough to discourage private vehicles to use it.
- Avoid the use of splitter islands on the approach legs of mini roundabouts, and use kerb build-outs instead to reduce the speed of motor vehicles entering the intersection.
- If kerbed, consider the use of native and other low-maintenance plants in centre island. Public art may also be considered.
- Multiple roundabouts at several intersections along the route are more effective at reducing motor vehicle speed than a single roundabout.

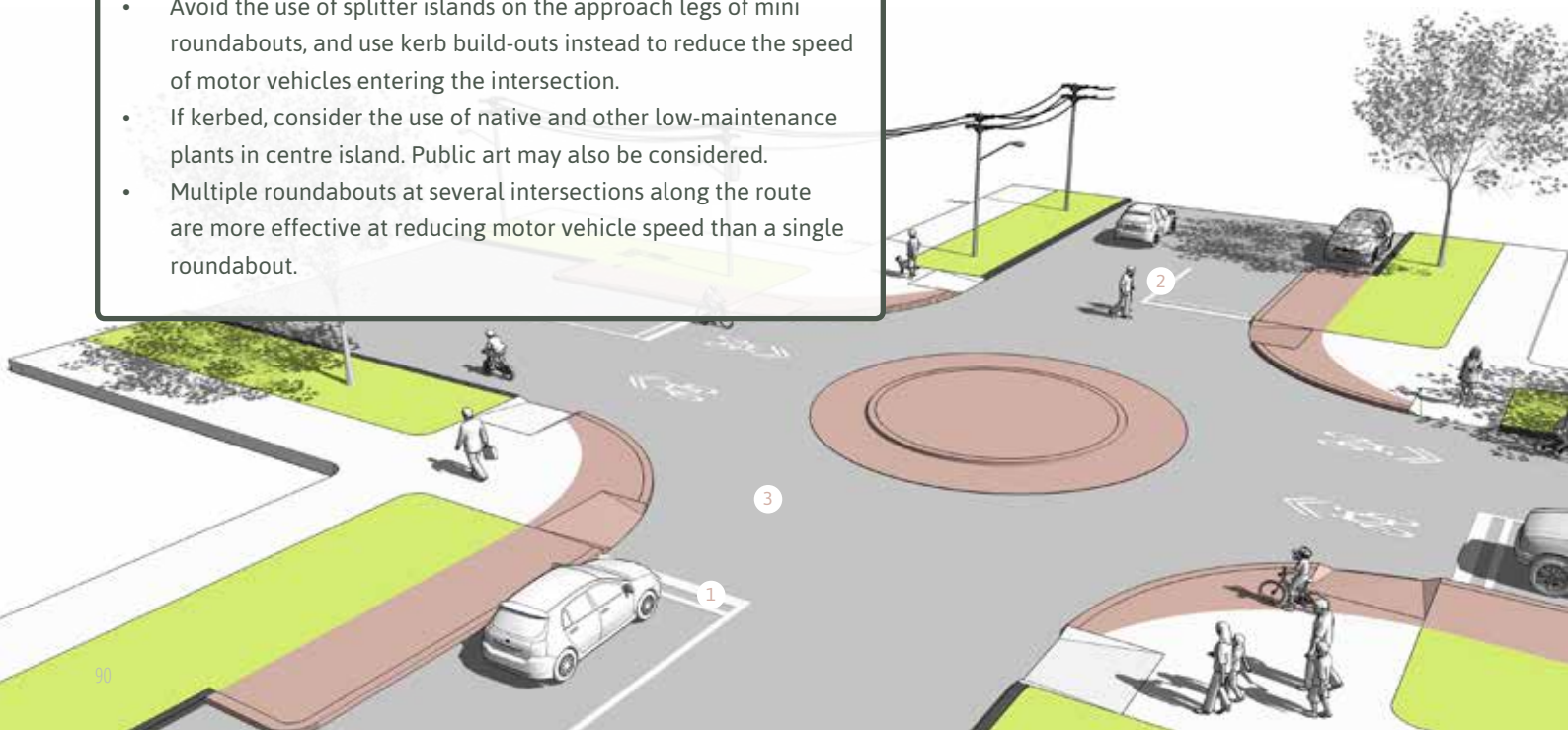

Typical

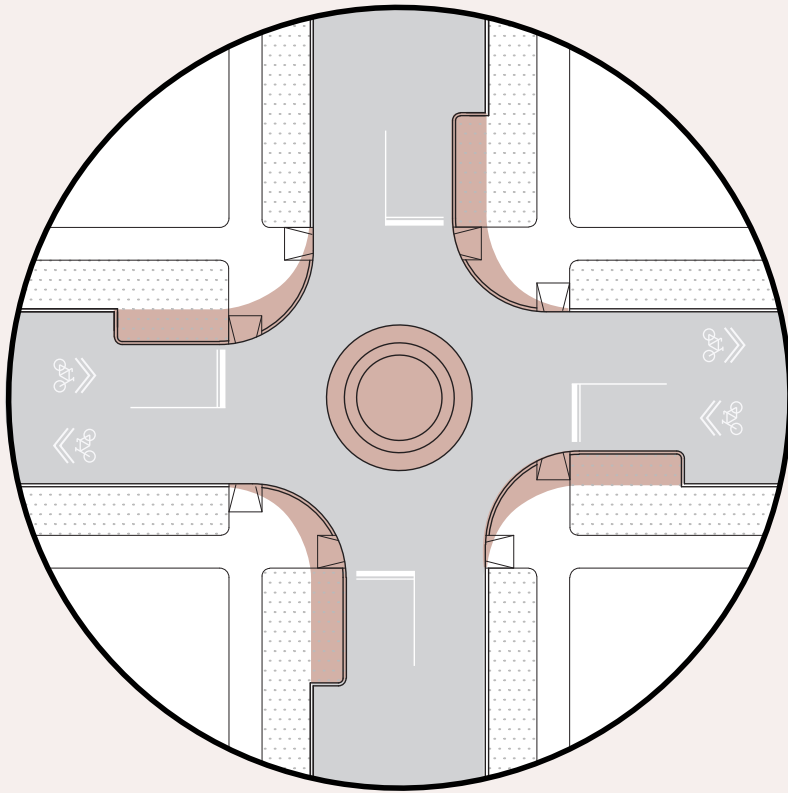

Design Parameters

- 1 Generally give-way controlled access for all approaches. Install a minimum of required markings.
- 2 Ensure crossing distances for pedestrians are minimised and consider using zebra crossings on all approaches.
- 3 Design speed for circulating the mini roundabout should be approximately 10-15 km/h.
- 4 Install roundabout signage (PW-8 sign) in advance of the mini roundabout.

Variations

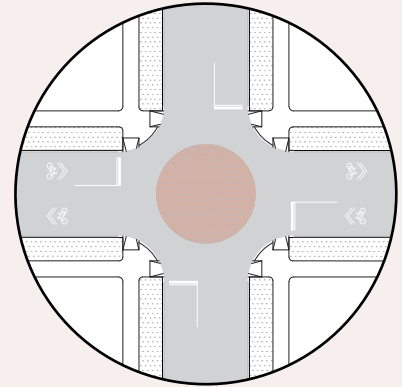

Painted_ A painted mini-roundabout can be a cost-effective alternative to the built roundabout at smaller intersections with lower vehicle speeds and volumes. A painted roundabout is not as effective at reducing speeds as a built roundabout, but it can be an effective low cost approach used as part of a tactical urbanism approach (see page 36). Adding planter boxes to the approaches can add additional traffic calming functionality. It can also be a good way to engage the community by allowing locals to help design or paint the intersection. This approach is common in the USA. See also, Intersection Repair in Tools for Placemaking (page 37).

Raised Table

Raised Tables are elongated speed bumps that use a ramp on either side of a flat platform to reduce vehicle speed. They are more comfortable than a speed bump and also more suitable for buses. However, the flat section reduces the slowing effect on motorists at the bump. Motorist design speed varies depending on design, particularly the grade of the ramp. Raised tables have been observed to reduce the 85th percentile vehicle speed by 18% (Ewing, 1999).

Cost ● ● ● ○ ○

See page 125 - 133 for more information

Recommended Usage

- On a neighbourhood collector street not designated as a major emergency response route, or with active transit routes.
- This tool is compatible with public transport. However, raised tables do slow down buses and there is an upper limit to the number of speed tables that can be used along a bus route (5). Ramp grade must be 1:20 for bus routes.

Design Considerations

- Often combined with pedestrian crossings and other traffic calming design elements. Can also be combined with a pinch point.
- Where a bus route has more than 10 speed cushions or 5 speed tables, other methods of traffic calming should be used where possible to avoid additional effects to bus service reliability.
- Use retroreflective pavement markings and signage to increase visibility at night.
- Slows down all vehicles, including buses and emergency vehicles.

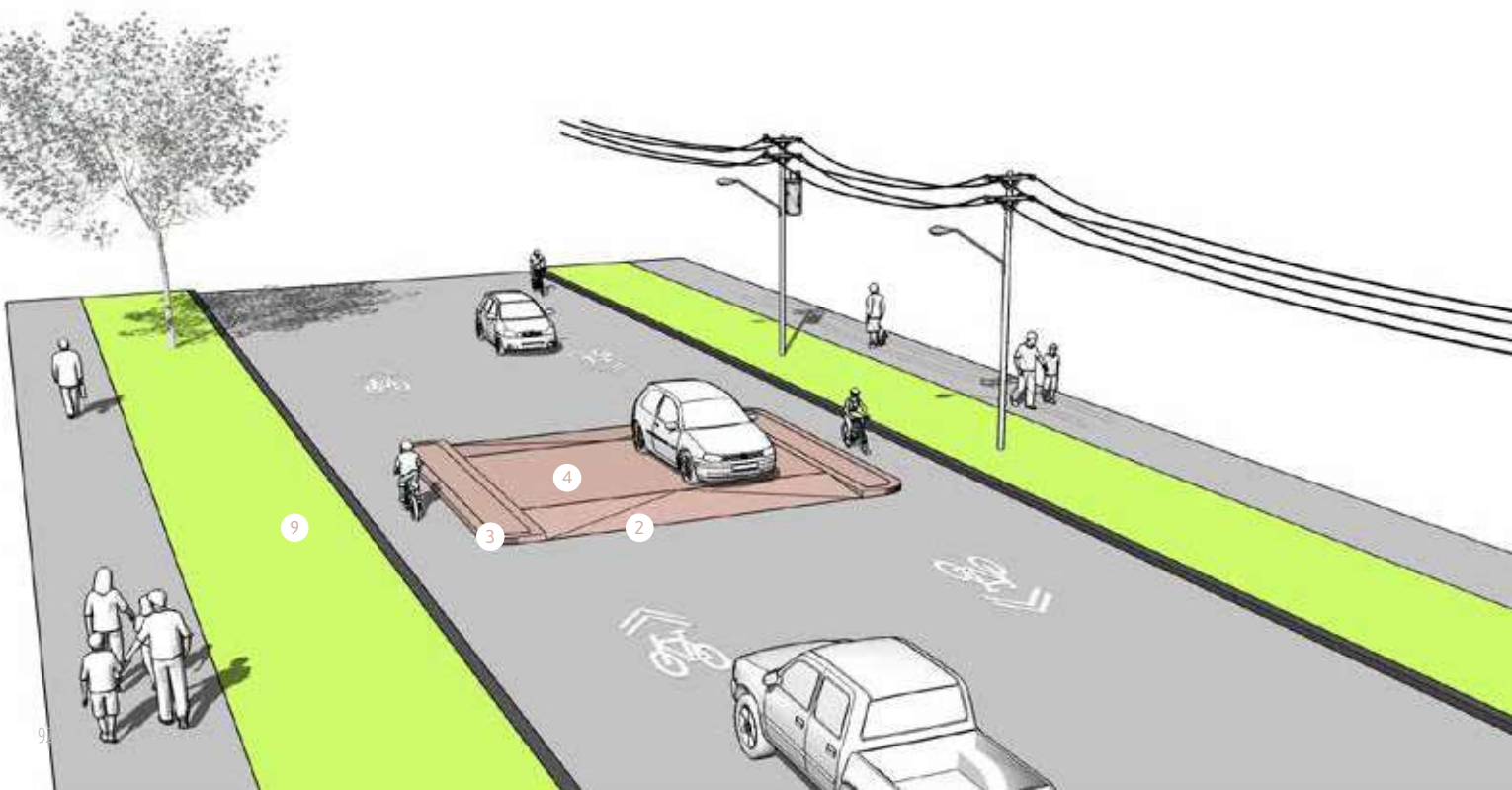

Typical

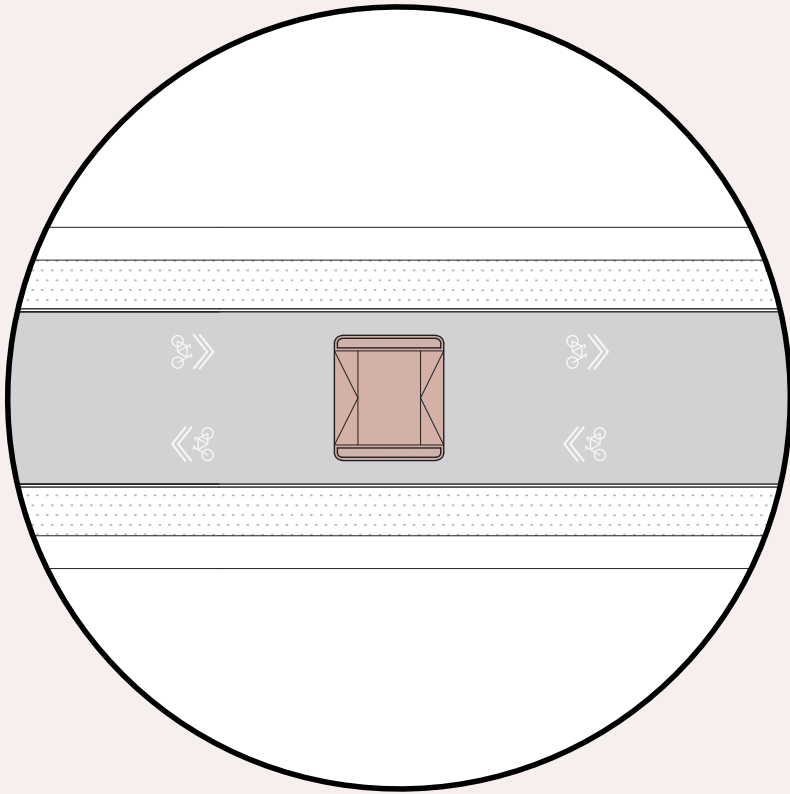

Design Parameters

- 1 Typically installed in a series, spaced 90-150m apart.
- 2 Ramp grade should be between 1:10 and 1:20 (busy bus routes)
- 3 Platforms should be 100-150 mm high
- 4 Platform should be one car length (6m) long to avoid “bottoming out”.
- 5 Install advance signage and markings to warn motorists and people on bikes that they are approaching speed tables.
- 6 Additional treatments (e.g., bollards) may need to be necessary to prevent motorists from driving around the speed table if constructed on streets without curb.
- 7 Do not use on sharp turns or steep slopes.
- 8 Carefully locate as to avoid conflict with underground utility access to boxes, vaults, and sewers.
- 9 Do not construct at driveway locations.

Speed Hump

Speed humps are placed across the road to slow traffic and are often installed in a series of several humps in order to prevent motorised vehicles from speeding before and after the hump. Speed humps are used on local streets to achieve appropriate speeds for residential streets. They typically have a parabolic or sinusoidal profile. A speed hump on a Local Path should be designed to be narrower in width than the street to provide cycle bypasses. This allows the speed hump to be slow down drivers without compromising the usability or comfort of people on bikes.

Cost ● ○ ○ ○ ○

See page 125 - 133 for more information

Recommended Usage

- Can be applied on 1 or 2 way non arterial roads with little truck traffic and no bus routes.

Design Considerations

- Effective tool to reduce speeding.
- Worst-case fire engine delay per speed hump is approximately 9.4 seconds.
- Speed humps do not have a suitable profile for use on bus routes and must not be used in this context.
- Speed humps should not be placed in driveways.
- To achieve greater speed reduction, place humps closer together.

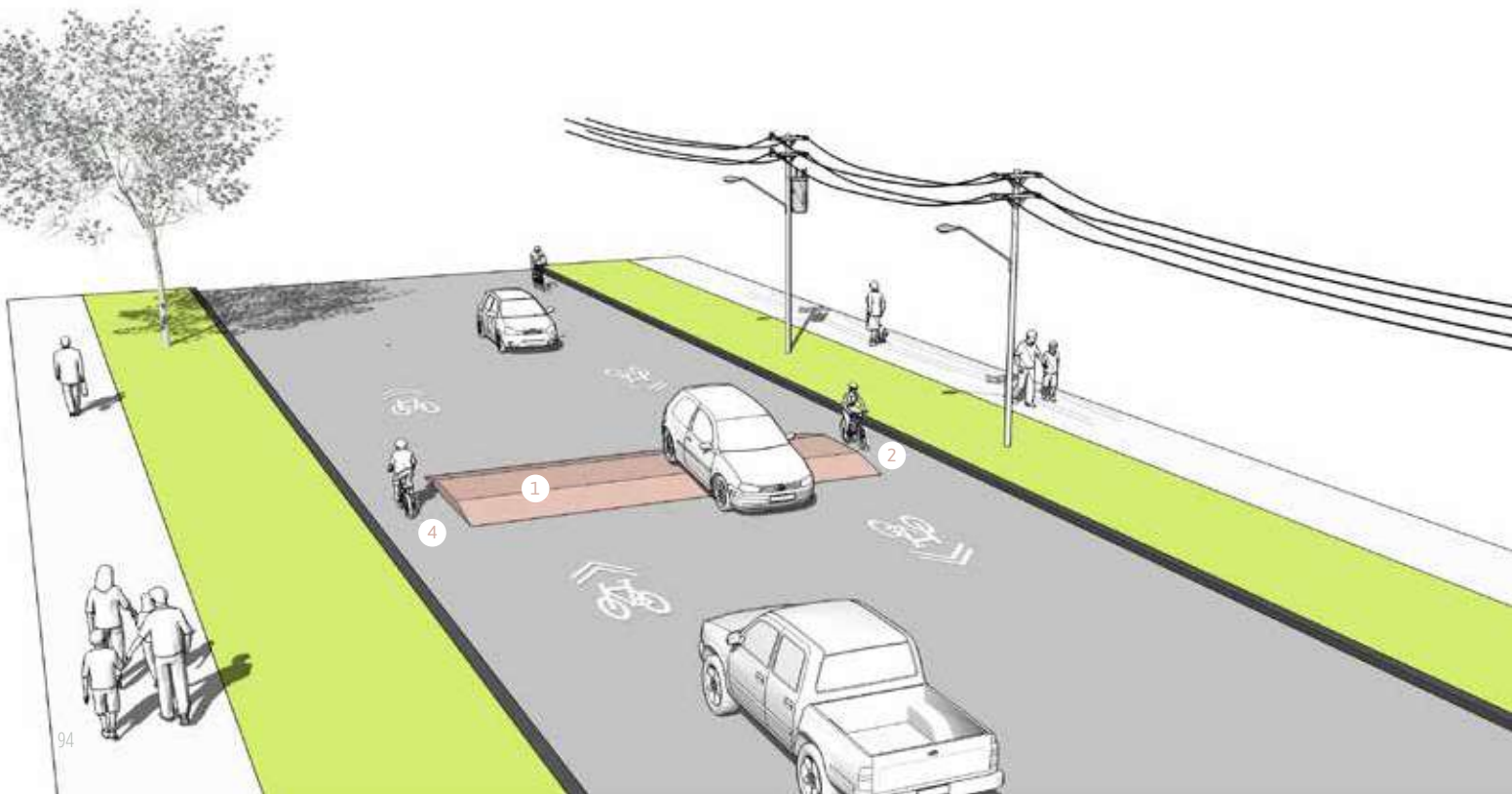

Typical

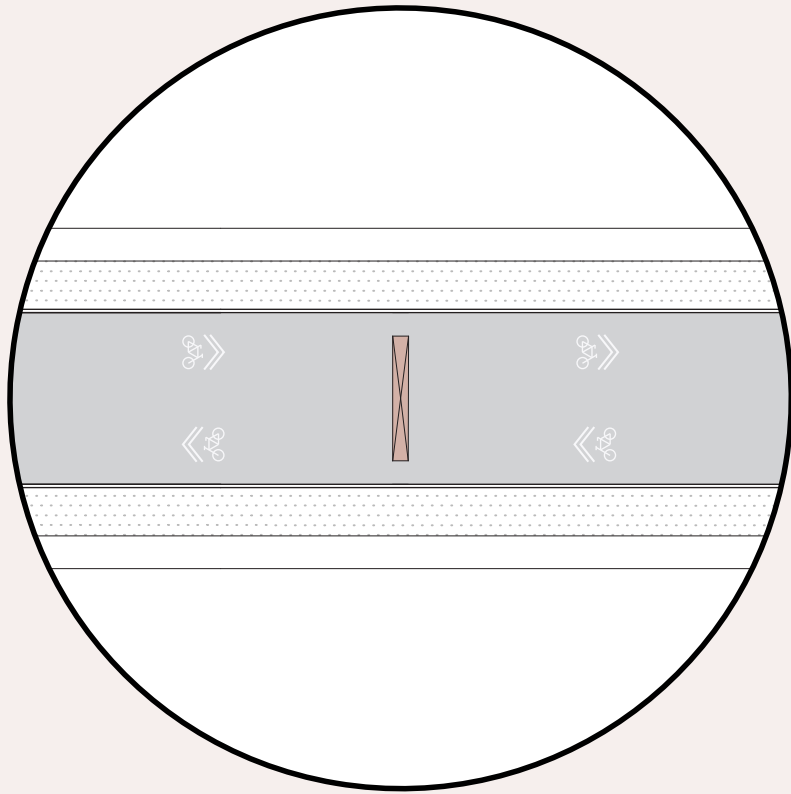

Variations

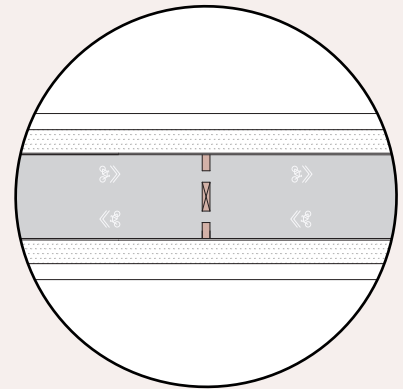

Speed hump with a cut through (away from the channel).

Design Parameters

- 1 They typically have a parabolic or sinusoidal profile, length between 1 and 3.7m, and height of 75 to 100mm. They can be placed 80m to 120m apart.
- 2 Speed humps should be installed at right angles to the path travelled by vehicles and should extend as close to the kerb as possible, but with a sufficient opening remaining for drainage.
- 3 Should be accompanied by a sign warning.
- 4 Cut-through for bicycles should be at least 1.0m wide. If next to the kerb, minimum width should be 1.5m.

Pinch Point

Pinch points introduce friction for automobile traffic. Instead of blocking one direction access, traffic in both directions is allowed, but restricted to a single lane, requiring opposing motorists to take turns passing through. Pinch points have been found to reduce speed by 14% and traffic volumes by 20%. Pinch points on Local Paths are similar to existing traffic calming devices located across Auckland except with two important distinctions. Primarily, the road reserve is narrowed to allow only one vehicle at a time. Secondly, a bypass is provided for bicycles on the outside edge, reducing the risk of bicycles getting side swiped.

Cost ●●●○○

See page 125 - 133 for more information

Recommended Usage

- The nature of this treatment makes it most appropriate for application along a neighbourhood Local Path, away from main road crossings. They can also be used for local and collector streets and main roads through small communities.
- This tool is compatible with public transport for lightly-trafficked bus routes only. Pinch points must be sited far enough away from bus stops as to not prevent obstruction.

Design Considerations

- Installation may reduce the availability of on-street parking.
- Preferred by many fire department/emergency response agencies to most other traffic calming measures.
- This type of traffic calming device relies on eye contact between drivers. Take care when implementing to ensure sufficient inter-visibility is available.
- Provides good opportunity for landscaping. Native and low maintenance plants or trees with high canopies are recommended to preserve sight distance.

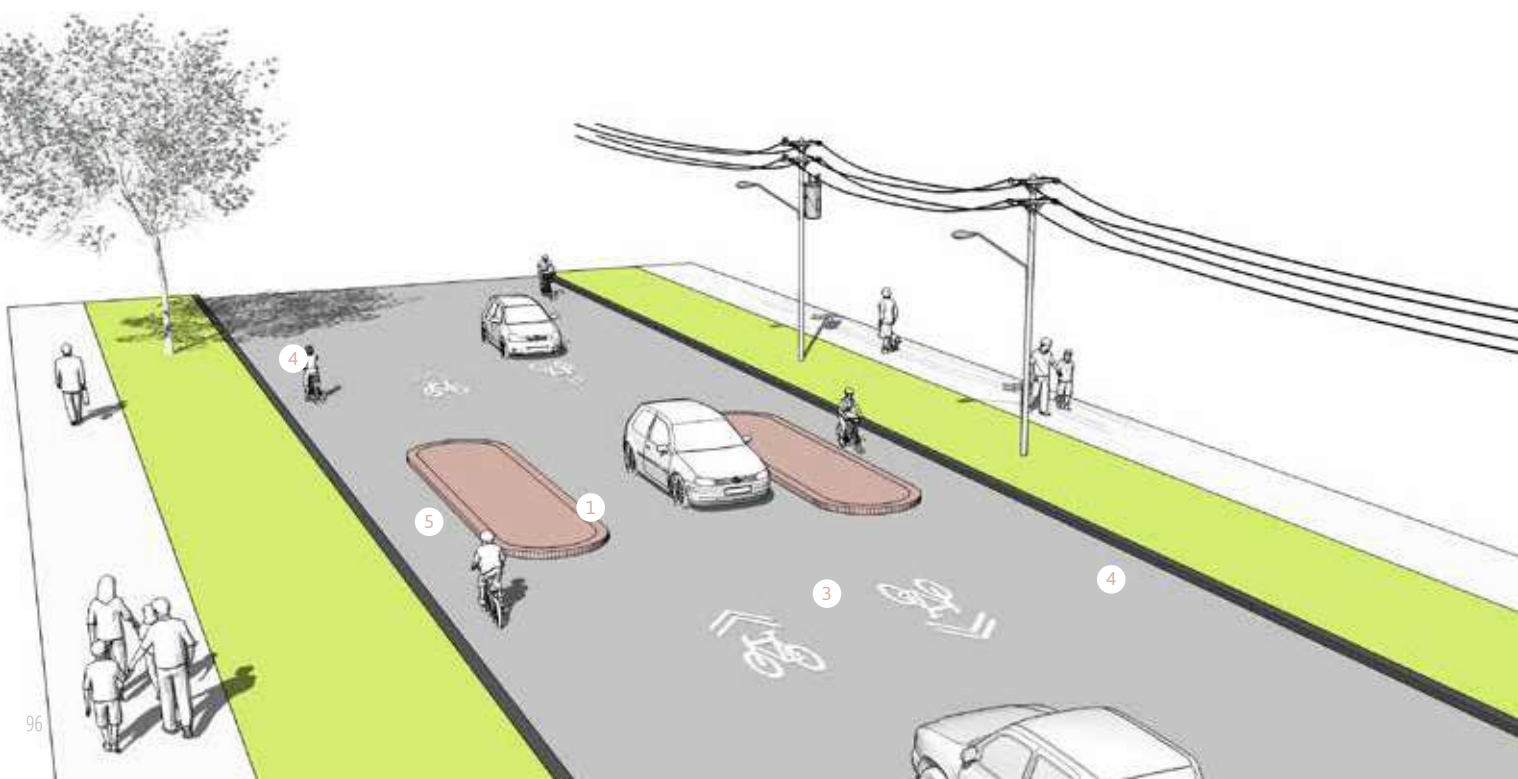

Typical

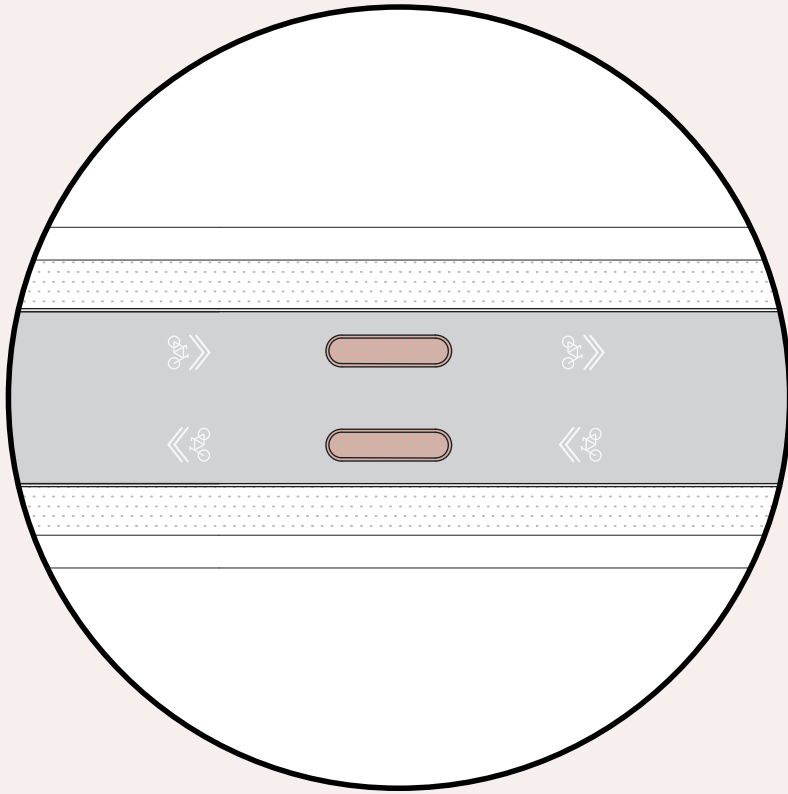

Design Parameters

- 1 Should be fitted with mountable kerbs to enable bigger trucks to pass through the chicane.
- 2 Vertical delineations, bollards or object markers are often used to enhance visibility.
- 3 Relies on regulatory signs and driver courtesy.
- 4 Parking restrictions are required on either side of the pinch point to allow people on bicycles to reach the bypass and merge back into traffic.
- 5 Bypasses should be a minimum of 1.5m wide.

Variations

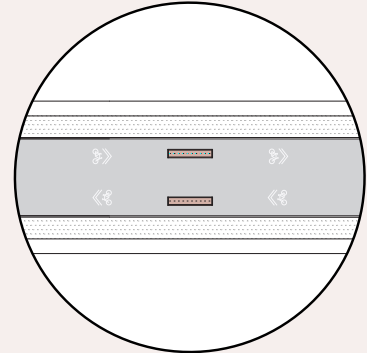

Planter Box_ To test the outcomes of the pinch point or to save on cost, planter boxes can be used.

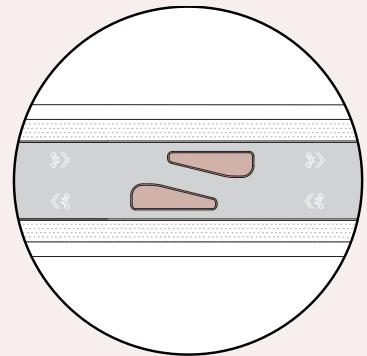

One Lane Chicane_ A chicane can help to visually narrow the street, create side friction and introduce modest complexity requiring motorists to shift laterally. A traditional chicane is not considered a safe solution for bicycles, as vehicles will have to swerve into and out of their path. A tight chicane, fitted with bicycle bypasses, will allow bicycles to travel past the chicane.

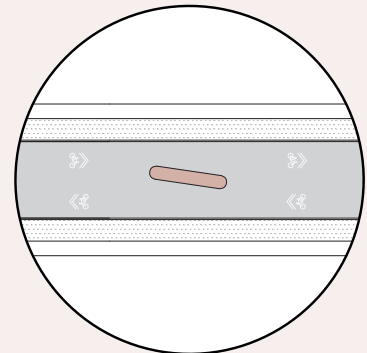

Short Centre Island Narrowing_ This consists of a short section of raised median, situated parallel to the Local Path. It causes a modest amount of deflection in passing vehicles. Driveway access is typically retained. Though the centre island narrowing at times acts as a de facto median refuge island for pedestrians, it is not a crossing treatment for Local Paths in this configuration.

Speed Cushion

Speed cushions are a variation to the speed hump that should only be used on key bus or emergency routes. Channels are added to permit trucks, buses and emergency vehicles to straddle the speed bump which minimises travel delay and discomfort.

Speed cushions are small rectangular humps, resembling a seat cushion in shape. They are approximately the width of a car and usually placed in rows of 2 or 3 across the road width. Cushions are rarely used individually but tend to form a series on a street or across as an area-wide treatment to maintain uniform speeds. Cushions are particularly good at offering traffic calming benefits without significant adverse effects on bus or emergency service access. However, their speed reducing capabilities might be reduced for larger SUV's and pick-up trucks.

Cost ● ● ● ● ●

See page 125 - 133 for more information

Recommended Usage

- Speed cushions should only be used on 2-lane critical emergency or bus routes that require traffic speed reduction.
- This tool is compatible with public transport. If vertical deflection is necessary along a bus route, speed cushions are preferred over speed tables. Cushions must be designed so that a bus can straddle the cushion comfortably, particularly when there are adjacent parked vehicles. Speed cushions should not be sited either at or on the immediate approach to or exit from a bus stop.

Design Considerations

- Design to accommodate the wheelbase of the emergency vehicle or bus (approx 2.0-2.1m).
- Estimated delay per device for a fire truck is under 2 seconds.
- Locate speed cushions where there is sufficient visibility and available lighting.
- Landscaping opportunities (if combined with kerb build-out or pinch point).

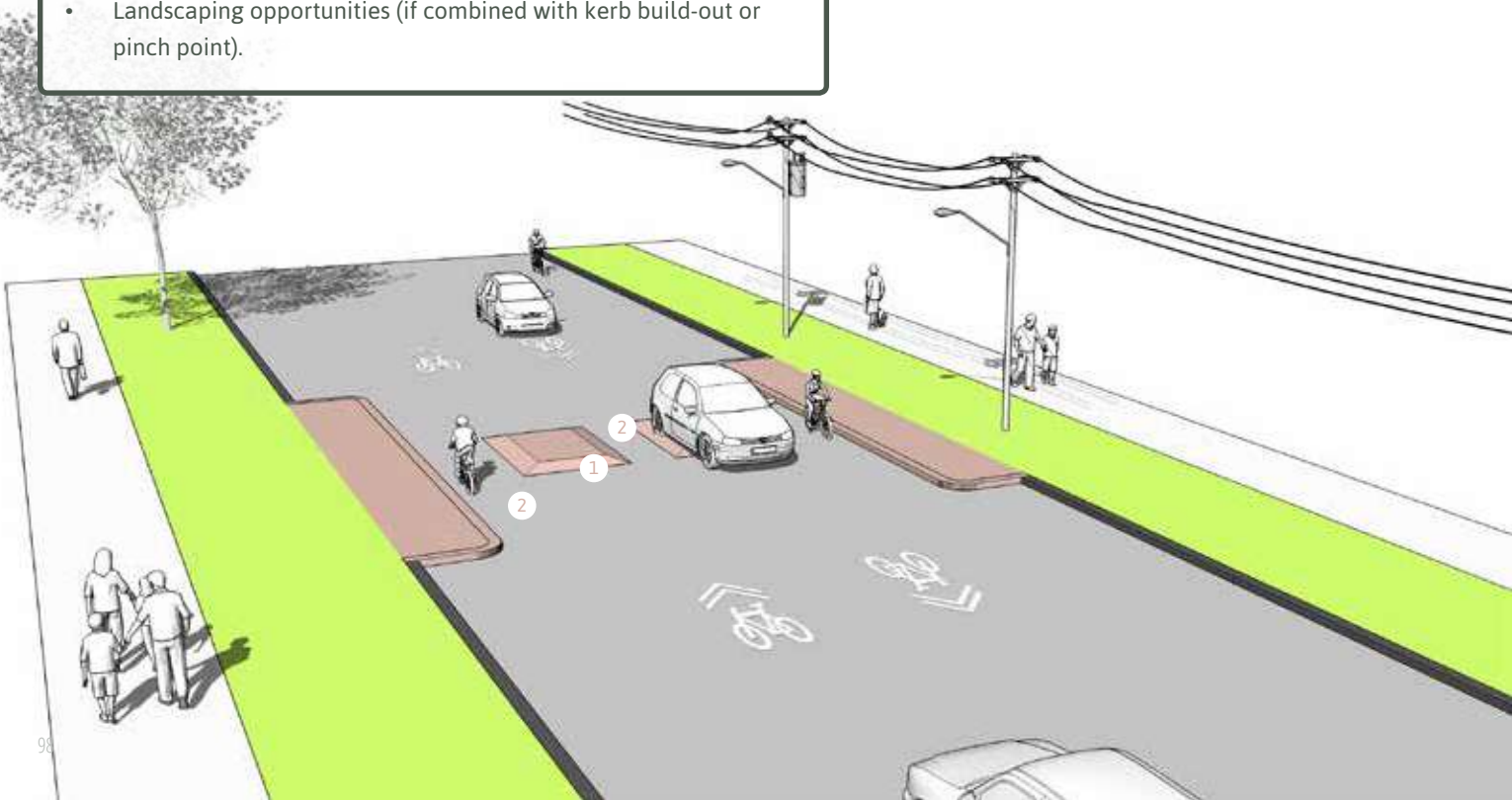

Typical

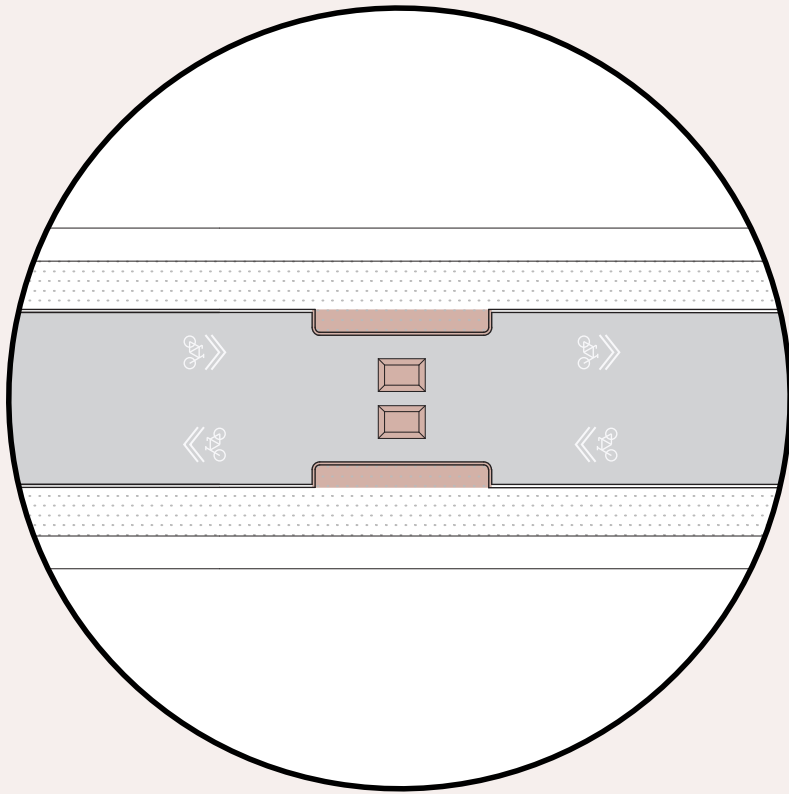

Variations

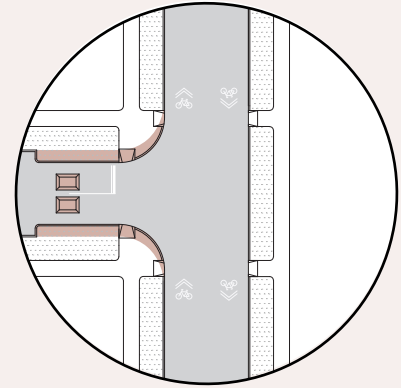

Approaching an Intersection_ Helps to reduce the approach speed of vehicles into an intersection, thus improving safety.

Design Parameters

- 1 The maximum height of a speed cushion is 75mm with an optimum width of 1.9m and a gradient formed at the ramp of 1:8.
- 2 The gap between cushion and kerb and between adjacent cushions should ideally be 1.0-1.5m, and no less than 750mm.
- 3 Gaps which are too wide (more than 1.5m) encourage drivers to drive through the gap at speed without the risk of grounding.

Raised Platform

A raised intersection is similar to a raised table but located at the intersection of two or more streets, raising the surface level of the entire intersection. The table extends into each of the streets running up to the intersection. This provides a flat raised surface at kerb height. A raised platform highlights the location of the intersection and lowers the speed at the conflict point, improving intersection safety.

A raised platform is an effective solution to deal with (minor) offset intersections or intersections where two Local Paths meet, as it provides a single, flush, low speed surface where bicycles can easily and safely manoeuvre across side streets. It also provides a flush surface for easy pedestrian crossings and thus is recommended in locations with a high number of pedestrians. With raised platforms, there is less reliance on signage and markings to control the intersection, similar to shared streets.

Cost ● ● ● ● ●

See page 125 - 133 for more information

Recommended Usage

- Raised intersections are recommended for intersections between two minor streets or between a minor street and a slightly busier street.
- To be implemented where speed is an issue.
- This tool is compatible with public transport, but should only be used on bus routes at key locations, such as schools or shopping centres. No more than 5 raised platforms on any bus route should be used. Heights of up to 75mm are acceptable, with entry and exit ramps no steeper than 1:15, with 1:20 preferred. The plateau should be a minimum of 6m long or 12.5m on articulated bus routes.

Design Considerations

- Stormwater implications. A raised crossing can interfere with the stormwater system and may prove costly to implement due to the requirement for additional catch pits.
- Line of sight should be available between all approaches.
- Ensure pedestrian footpaths are flush with the raised platform.
- Different surface typology can be used for the table top. This can be used in conjunction with "intersection repair" tools.

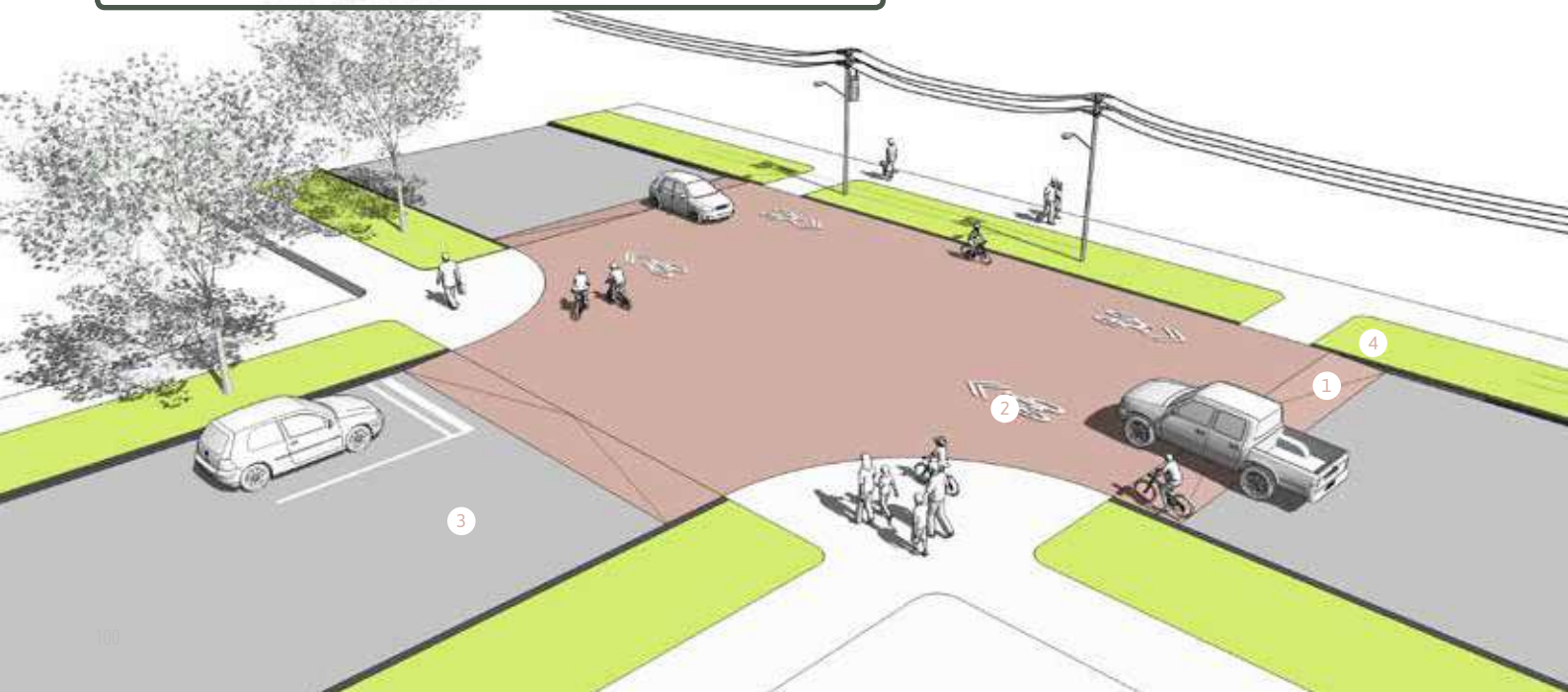

Typical

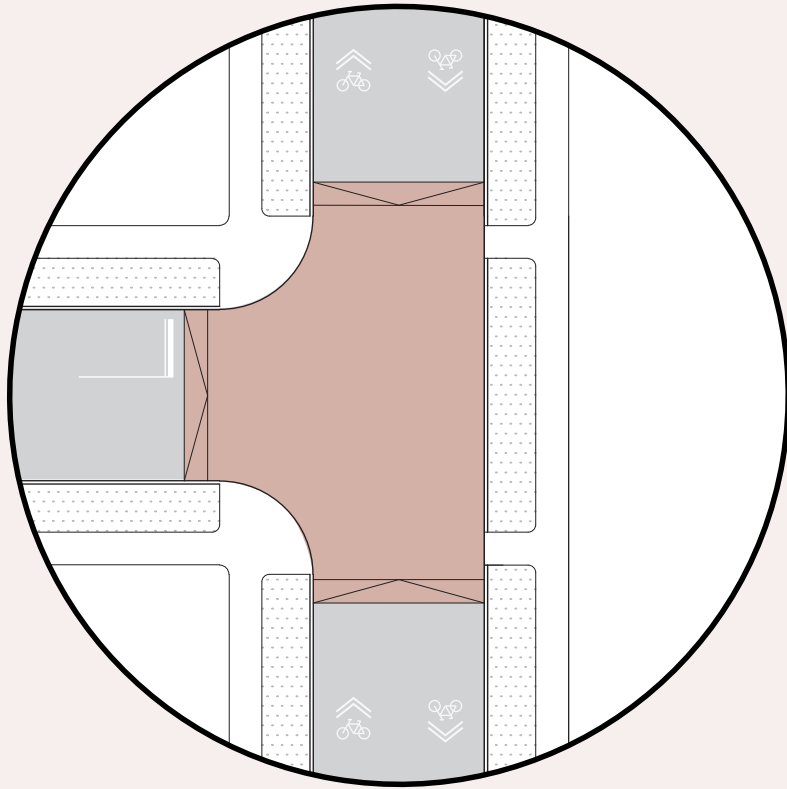

Variations

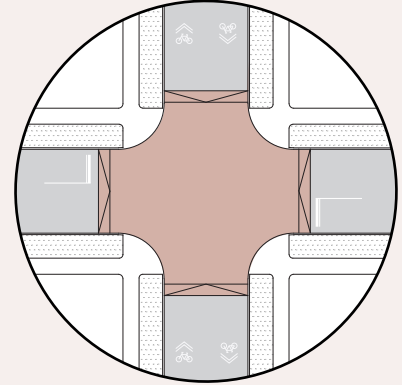

X-intersection

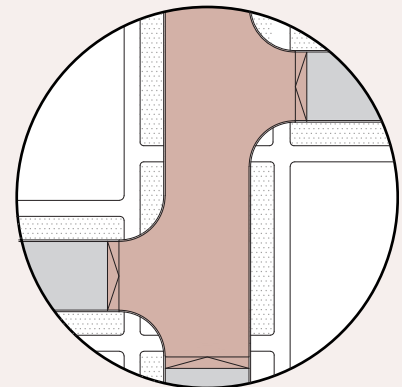

Offset Intersection

Design Parameters

- 1 If a bus route is present, reduce the slope of the ramps to 7% (1 in 15).
- 2 Add sharrows or other wayfinding tools to ensure bicycles can easily navigate the intersection.
- 3 The slope of the ramps leading into the raised intersection should be 10 (1 in 10) to 12% (1 in 8) where no bus routes are present.
- 4 The level of the raised platform should be flush with the kerbs. Driveways may also have to be rebuilt to meet the platform level.
- 5 Give way markings may be required where normal give way rules are not appropriate or sufficient.

3.5

TOOLS FOR CROSSING THE STREET

At intersections with arterial or collector roads, Local Paths should be designed, built and maintained to provide a minimum of 50 crossing opportunities per hour.

Crossing the street should be safe, direct, comfortable and convenient. Tools for crossing the street take the form of constructed interventions located mid block or at intersections. Tools for crossing the street also reduce traffic speeds. To ensure people can safely cross arterial roads without too much delay, a minimum target of 50 crossing opportunities (either signalled or unsignalled) per hour is required, but the preferred number is 100 crossing opportunities per hour. It is important to take into consideration that crossings may affect arterial road traffic and may not be feasible in all locations.

Offset Intersection Crossing

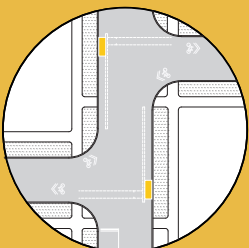
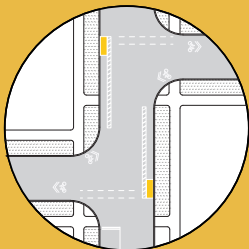
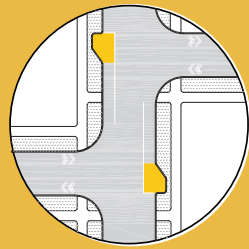
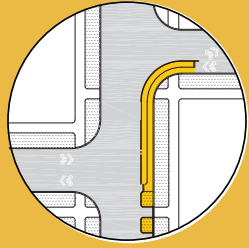

Zebra Crossing

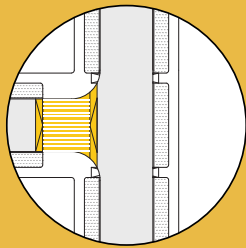
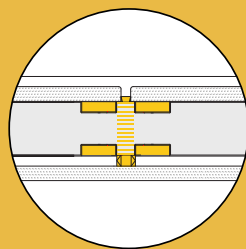
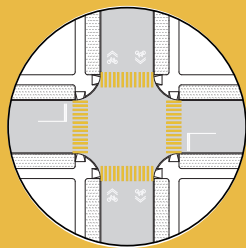

Courtesy Crossing

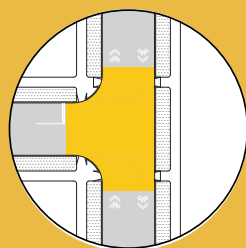
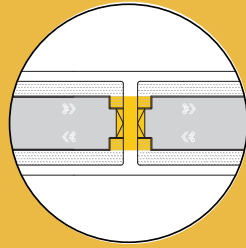
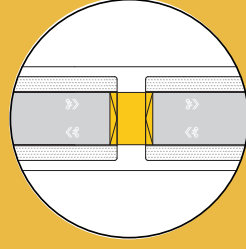
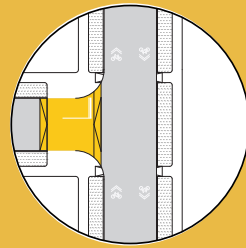

Kerb Build-outs

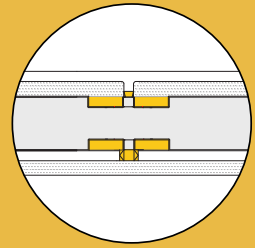
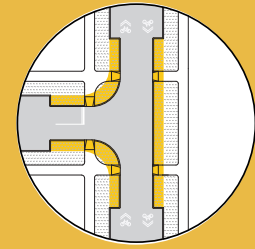
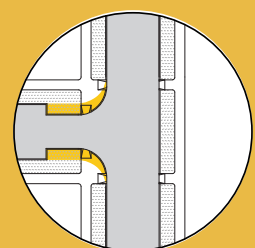

Pedestrian Refuge

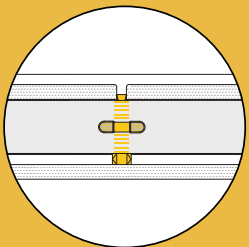
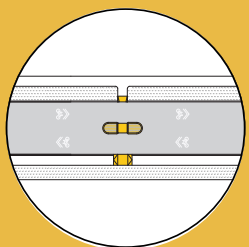

Signalised Crossing

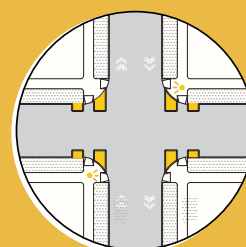

Offset Intersection Crossing

Auckland's street network has many offset intersections. These can be particularly hard to navigate by bicycle as it includes a left turn and a subsequent right turn. There are various ways to deal with this problem. The right solution is very dependent on the local circumstances. Where a Local Path crosses an arterial road with a wide median, it is possible to implement a bidirectional cycleway within the median. This cycleway would be protected by small buffers either side. This allows bicycles to cross only one lane of traffic at a time.

Cost ●●●○○

See page 125 - 133 for more information

Recommended Usage

- Recommended to be implemented in locations where there are no signals available and traffic volumes are relatively high. Not to be used on arterials with more than one lane in each direction.
- This tool is compatible with public transport.

Design Considerations

- Ensure enough space is available for a narrow protective buffer at either side to ensure no vehicles enter the central cycleway.
- A central cycleway also limits vehicular traffic in the side streets by turning both side streets into a left-in/left-out only configuration.
- Carefully consider pedestrian desire lines to ensure they will not be tempted to cross through the central bit, as this might result in pedestrian/bicycle conflicts.
- Can be combined with a zebra crossing either side to enhance pedestrian amenity at the same time.
- Additional traffic calming features might be required to highlight the bicycle and pedestrian crossings.



Typical

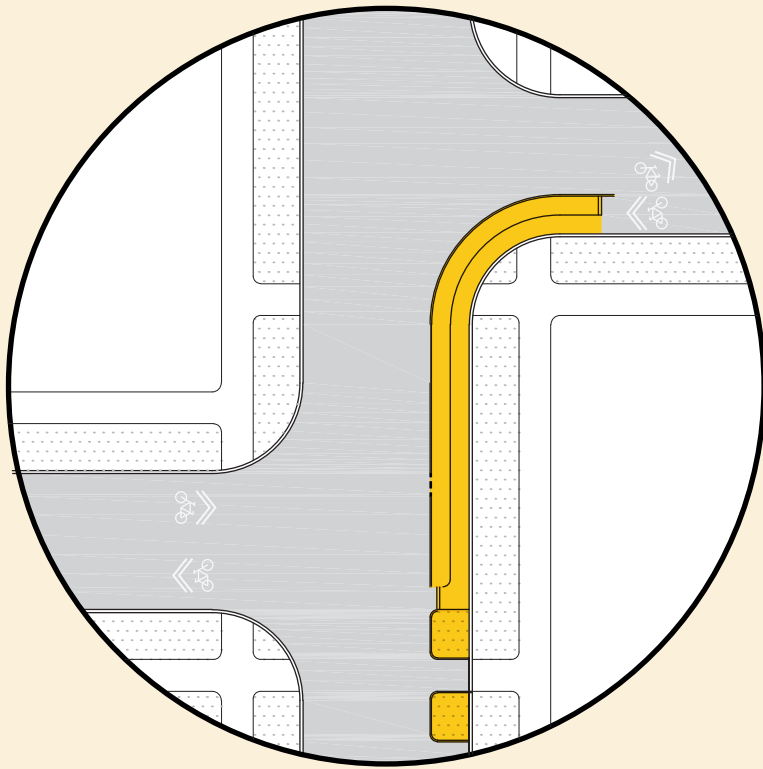

Design Parameters

- 1 Cycle lanes can be fairly narrow (2.0 - 2.5m), as speeds will be low and the median will only be in place for a short section.
- 2 Physical buffers should be approximately 0.3m wide.
- 3 Bidirectional cycle lanes preferably are vertically separated from the carriageway and continue on 20-30m into the side street to allow for safe merging back into the road.

Variations

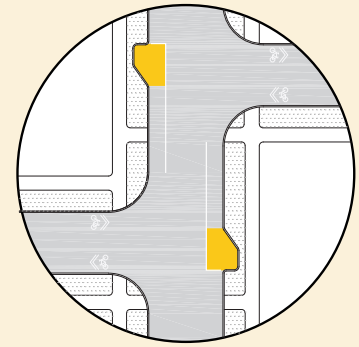

Two-stage Turns_ Where a Local Path crosses a road with bicycle lanes, the easiest way to cater for offset movements is to provide a right turn box for bicycles to wait before turning right into the opposite side street.

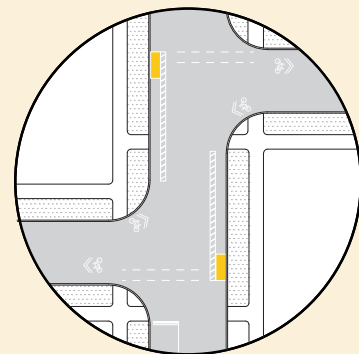

Two-stage Turn Queue Boxes at Signalized Intersection_ This treatment is most appropriate where Local Paths cross major roads. To facilitate crossing them, intersection crossing markings may be applied. Where the Local Path crosses a street with another cycleway, the queue boxes provide space to wait for a crossing opportunity for people on bikes turning onto the Local Path, without blocking people on bikes who are continuing on the road.

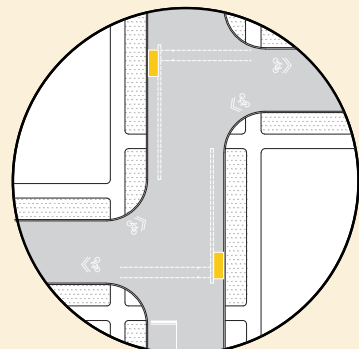

Cycleway Connection_ Where a Local Path crosses an offset intersection with a road featuring a cycleway, the Local Path can make use of the cycleway to connect across the intersection.

Zebra Crossing

Zebra crossings are marked by white painted stripes across the road and flashing amber beacons or reflective discs mounted on black and white poles. A white limit line must, if practicable, be marked to show motorists where to stop. White diamonds are generally painted on the road before the crossing.

Zebra crossings can be an effective way to reduce vehicle speeds and raise awareness while significantly improving pedestrian amenity. An intersection with zebra crossings on each of the four legs highlights pedestrian crossing movements and slows down vehicles, as they have to yield to pedestrians.

Cost ●●●○○

See page 125 - 133 for more information

Recommended Usage

- Recommended to be used in areas with high pedestrian traffic such as around schools and town centres or major transit stops.
- Series of zebra crossings potentially improve the safety record, as drivers will be expecting zebra crossings.
- This tool is compatible with public transport.

Design Considerations

- The application of zebra crossings in locations with currently low numbers of pedestrians may prove to be problematic, due to NZTA warrants required to implement zebra crossings.
- Zebra crossings on straight sections of road should be at least 100m apart.
- Do not install on sharp turns or steep grades.
- A trial is recommended to allow bicycles to use zebra crossings without dismounting.

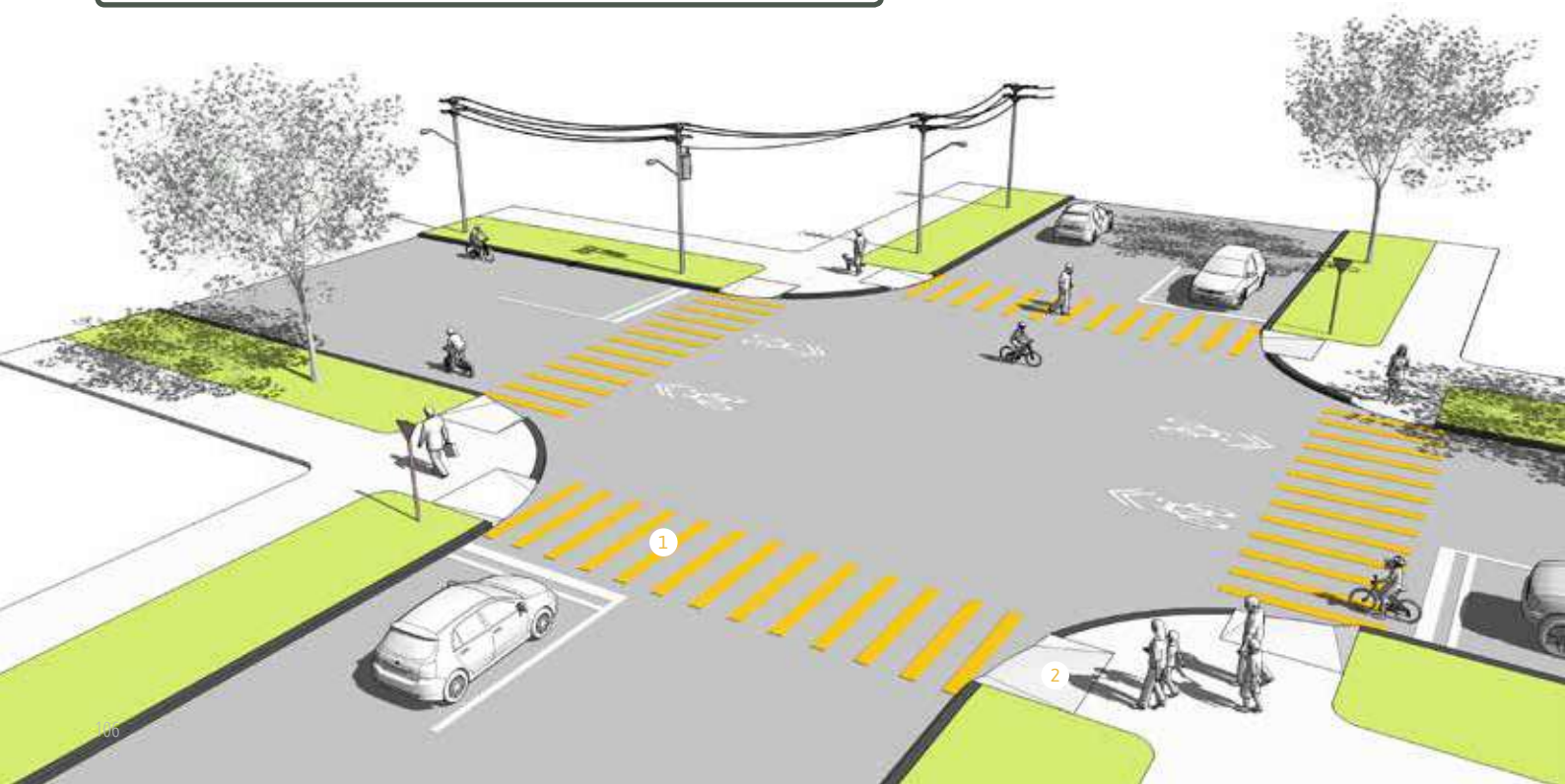

Typical

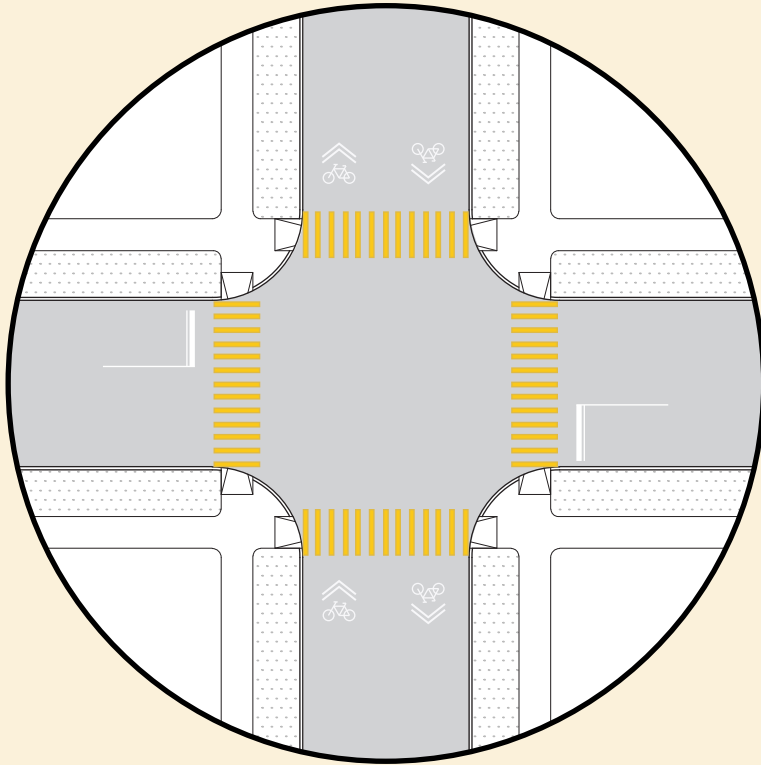

Variations

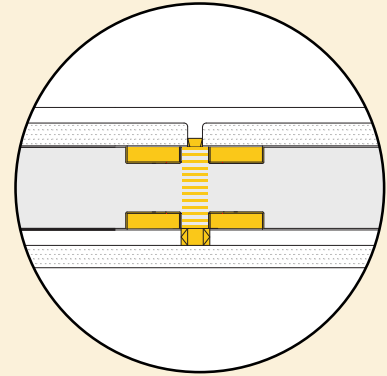

Paired with Kerb Extension_ In combination with zebra crossings, this variation shortens the crossing distance (may eliminate some on-street parking). A refuge island can assist crossing roadways with higher traffic volumes and/or multiple lanes. Give-way signage and pavement markings can also be added. Low planters can be used for low cost kerb build outs that don't interfere with stormwater systems.

Design Parameters

- 1 Use retro reflective pavement markings and signage.
- 2 Install high-contrast and tactile directional strips at the edge of the zebra crossing to aid the visually impaired. See ATCOP for details.
- 3 Install advanced warning signage and pavement markings in accordance with MOTSAM.

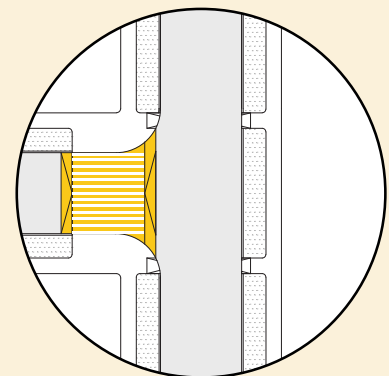

Raised Zebra Crossing_ A raised zebra crossing has significant safety benefits over a non-raised crossing, but comes at significant cost. This should be considered in more high speed environments or where high pedestrian volumes are expected. See Raised Table tool (pages 88-89) for further guidance.

Courtesy Crossing

Courtesy crossings are crossings where pedestrians do not have legal right of way, but they highlight a good place for pedestrians to cross. A courtesy crossing can be a flush painted or textured strip, or a raised crossing. They are often incorporated into intersections. This tool creates a visibly prominent crossing location for people on bikes and pedestrians. The threshold created by a courtesy crossing signals a change in environment from busier, faster arterial roads to slower, local streets. This means that the treatment will (in theory) make it slightly easier for pedestrians to cross, however there is no formal requirement for vehicles to give way to pedestrians.

A raised crossing reduces the vehicle approach speed and provides a flush crossing point for pedestrians. A courtesy crossing is not fitted with zebra markings, which make them more appropriate for locations where the requirements for a zebra crossing warrant are not met.

Cost ● ● ● ● ●

See page 125 - 133 for more information

Recommended Usage

- Recommended for locations that do not meet the zebra crossing warrant but where increased safety and pedestrian amenity is desired, and the desire lines want to be acknowledged.
- Can be used to introduce the slower zone for a Local Path.
- Flush treatments are recommended for public transport routes.
- Use in combination with intersection repair treatment (see page 37) or as part of a tactical approach to test locations of future zebra crossings.

Design Considerations

- Surface treatments (cobblestones, thermoplastic markings) are recommended to provide tactile feedback to drivers.
- The choice of marking can be influenced by the local character and in conjunction with community engagement.
- Be mindful of conflicts with existing driveways.
- Raised crossings need to consider the ramp transition so vehicles don't 'bottom out'.
- Raised tables may require additional changes to stormwater systems, which can be costly.

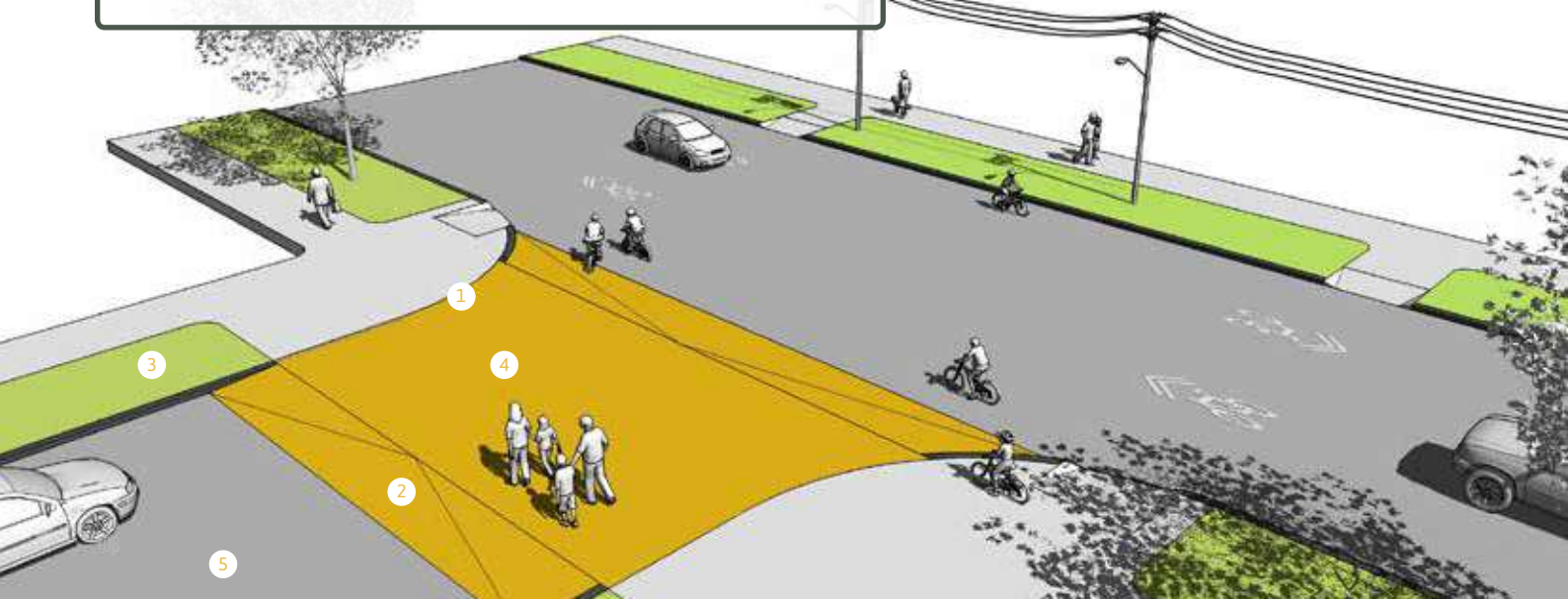

Typical

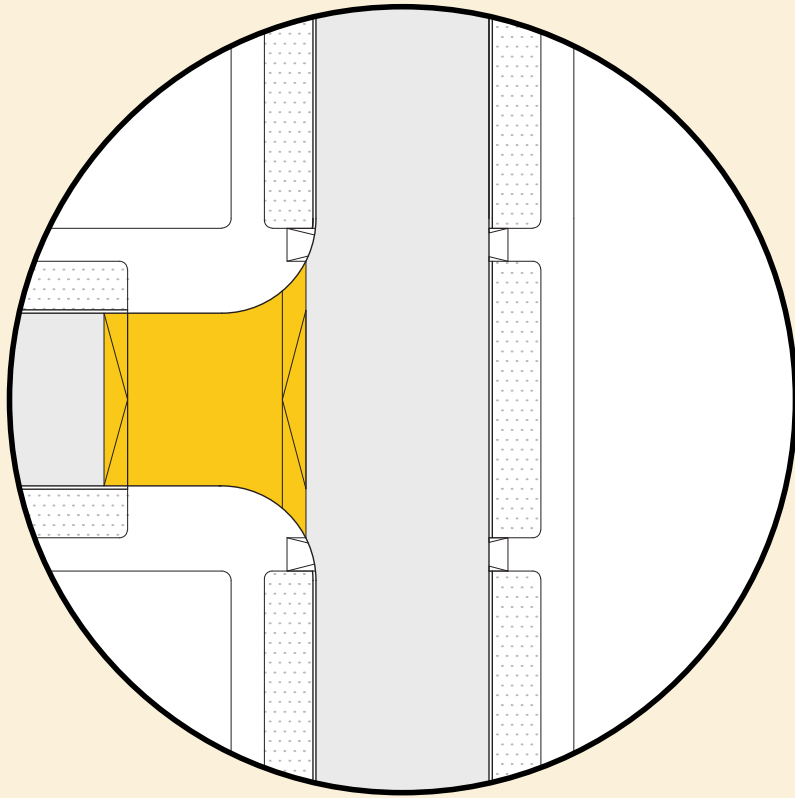

Design Parameters

- 1 The speed table portion of a raised table should be raised to the height of the kerb.
- 2 Ramp approach should be 1:15 on bus routes and 1:10 on non-bus routes.
- 3 Install advanced warning speed limits and advisory signage.
- 4 Top of the speed table should be at least 6m wide to allow a vehicle to sit on top.
- 5 Use on streets with no more than two traffic lanes.

Variations

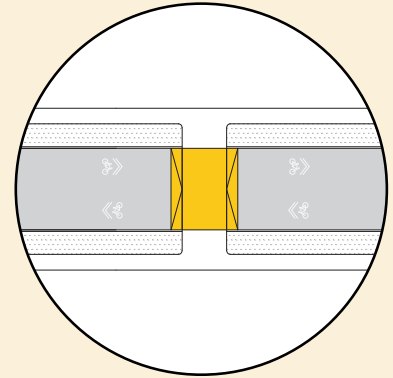

Mid-block Crossing_ Can be used as a mid block treatment at transition points with intersecting Local Paths or footpaths.

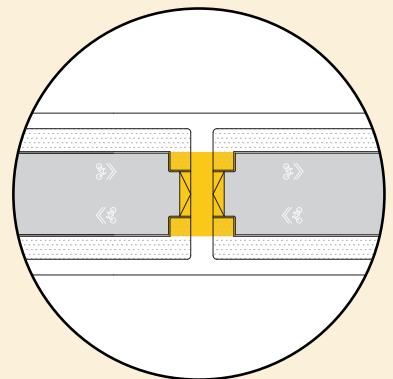

Paired with Kerb Extensions_ A raised crossing in combination with kerb extensions is suitable for particularly wide streets with speed issues. This will further slow vehicles down. Build outs ensure no vehicles park on the raised table and also provide space for low planting.

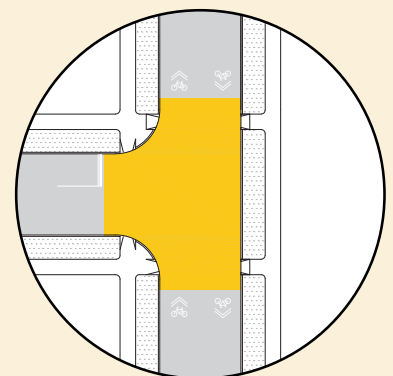

Courtesy crossings can extend to an entire intersection

Kerb Build-outs

Kerb build-outs extend the sidewalk or kerb face into the carriageway at an intersection, serving as a visual cue that drivers are entering a neighbourhood street area. They are also useful in reducing vehicle speeds, as they physically narrow down the carriageway and increase awareness of drivers. Kerb build-outs are a commonly used tool for pedestrian crossings and are often implemented as part of safer schools programmes. Properly designed kerb build-outs do not interfere with existing stormwater systems and can be implemented fairly quickly and cost-effectively.

Design Considerations

- If the street is frequently used by larger vehicles, such as (school) buses and trucks, modify the design to accommodate these.
- Kerb extensions may be treated with corner street furniture and other amenities.
- Kerb extensions offer opportunities for native low planting to increase permeable surface.

Cost ● ● ● ● ○

See page 125 - 133 for more information

Recommended Usage

- Install at intersection, to denote a gateway to slower zones or mid-block crossing points.
- Used as “book-ends” to highlight the location of the Local Path to approaching drivers.
- This tool is compatible with public transport.

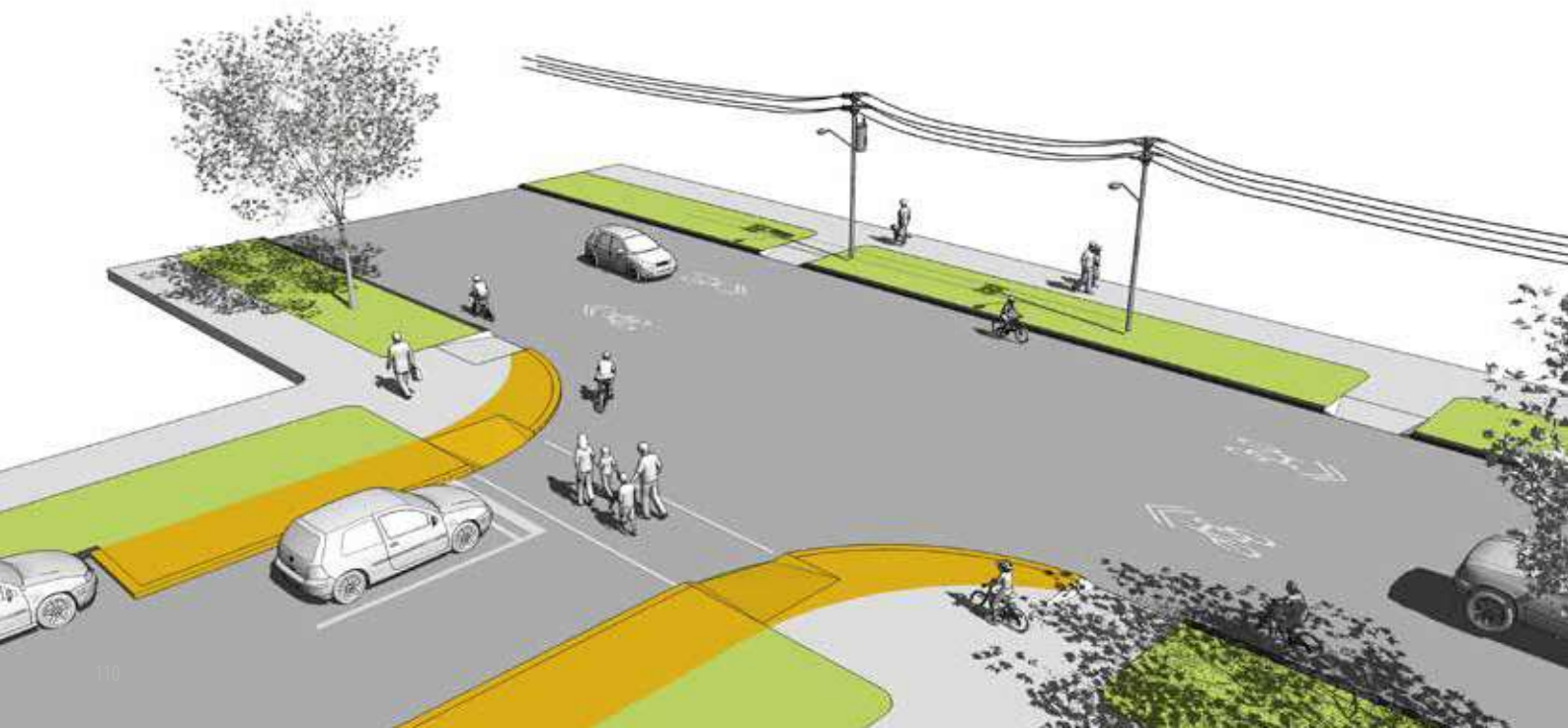

Typical

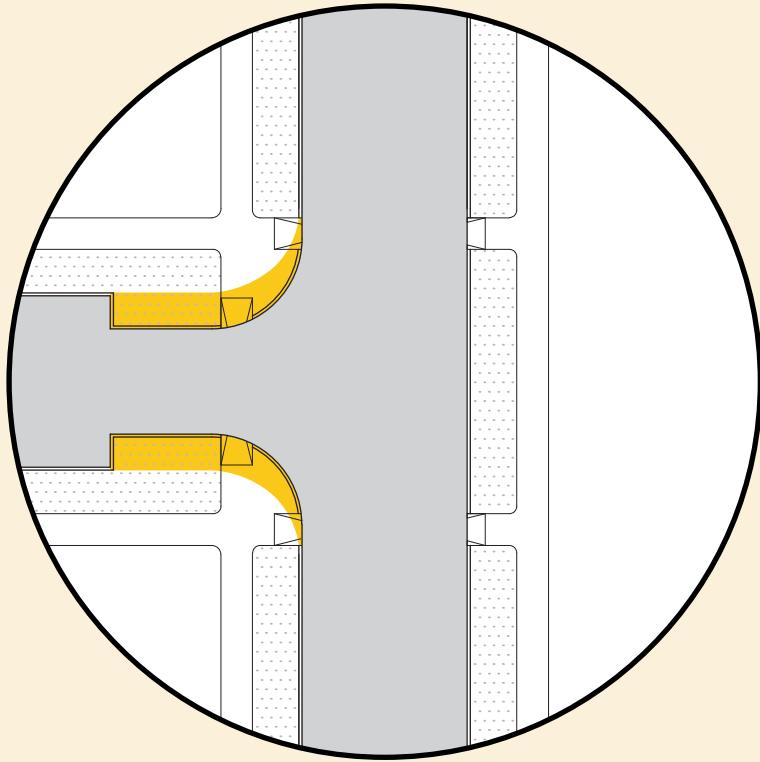

Variations

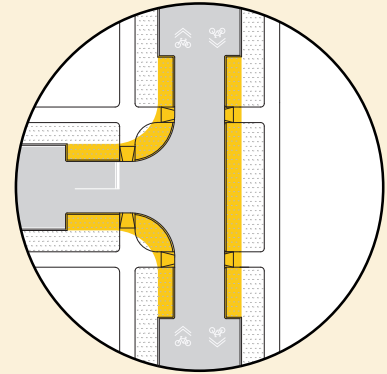

Build outs_ Build outs can be applied to every crossing at an intersection to maximise pedestrian visibility and slow speeds

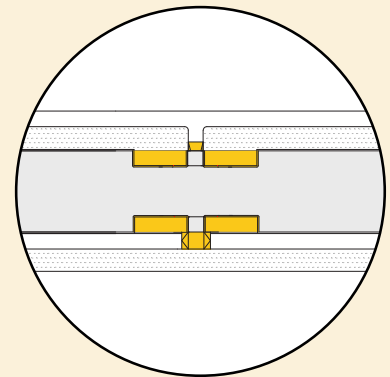

Mid-block kerb build-out_ A mid-block kerb build-out can be used to highlight a Local Path crossing a local street. This is not recommended for busier streets.

Design Parameters

- 1 Must not obstruct travel lanes or bicycle lanes when present.
- 2 If landscaped, plant with low growing shrubs to preserve sight distance and native plants to reduce maintenance.

Pedestrian Refuge

Pedestrian refuges reduce the time a pedestrian in the intersection is exposed to traffic. While pedestrian refuges may be used on both wide and narrow streets, they are generally applied at locations where speeds and volumes make crossings prohibitive or where three or more lanes of traffic make pedestrians feel exposed or unsafe in the intersection.

Cost ● ● ○ ○ ○

See page 125 - 133 for more information

Recommended Usage

- Particularly useful in locations with relatively high vehicle flows but acceptable speeds.
- This tool is compatible with public transport.

Design Considerations

- The roadway must be wide enough to accommodate the crossing island, two-directional travel, and bike lanes if used. This may require elimination of on-street parking and/or travel lanes, or narrowing of travel lanes.
- Pedestrian refuges may be incompatible with truck turning radii. In cases with considerable truck traffic, kerb build-outs are preferable.
- Pedestrian refuge may be enhanced using plantings or street trees. This may require additional maintenance responsibilities and need to be maintained to ensure visibility.

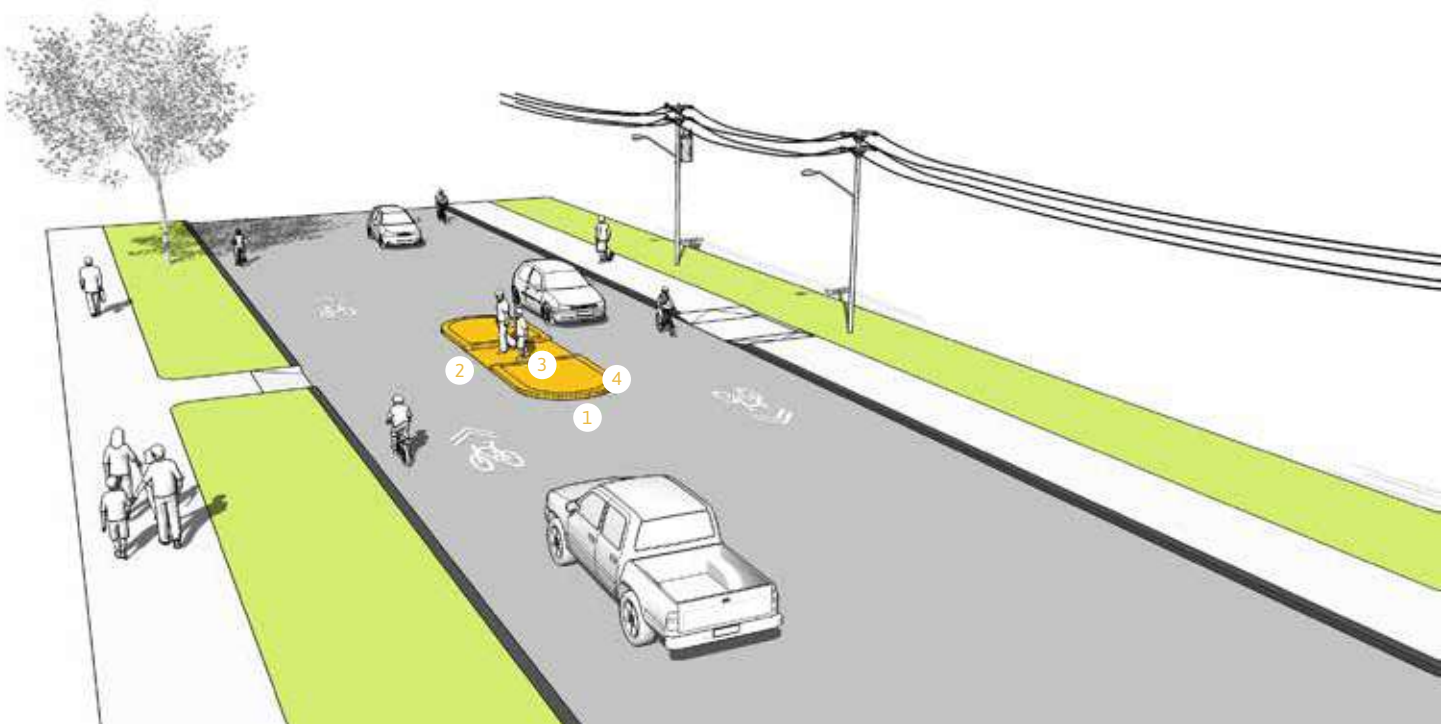

Typical

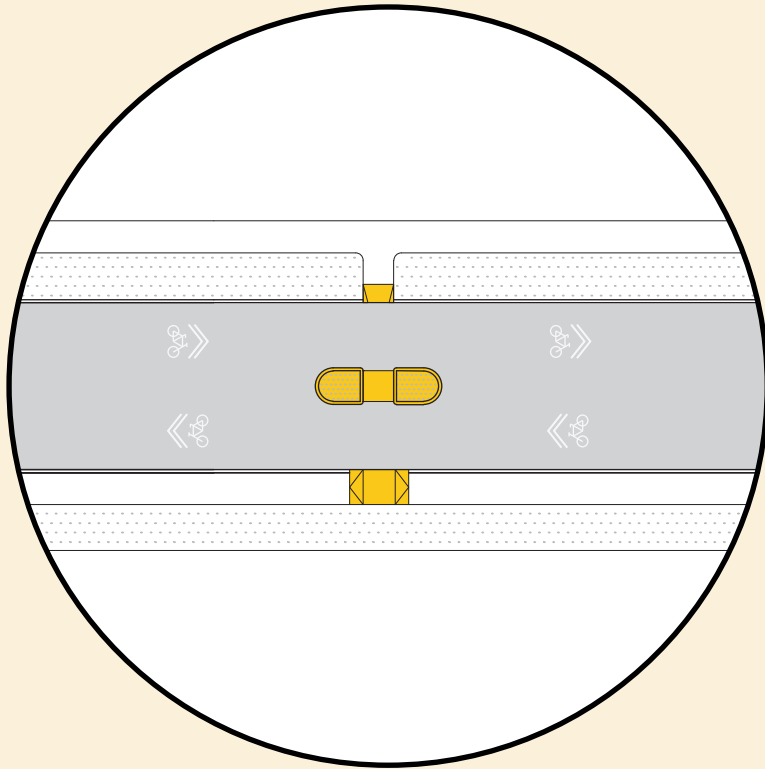

Variations

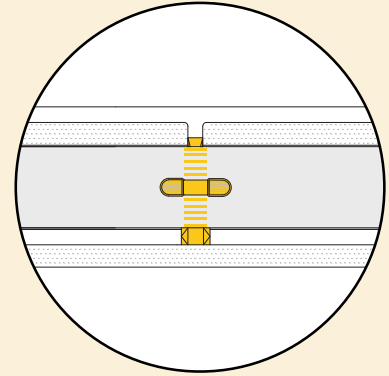

Zebra crossing with refuge_
On particularly busy streets, a combination of a zebra crossing and a pedestrian refuge can be useful to add protection to an otherwise long zebra crossing.

Design Parameters

- 1 All pedestrian refuges should have a “nose” that extends past the crossing. The nose protects people on the island and slows turning drivers.
- 2 The cut-through or ramp width should equal the width of the crossing points. Where this cannot be achieved, crossing points should be striped wider than the cut-through area.
- 3 Refuges should be 2 to 3m wide. Where this cannot be attained, a narrower raised median is still preferable to nothing. The minimum width is 1.6m to accommodate a pram. The refuge is ideally 10-12m long.
- 4 Refuges should include non-mountable kerbs and can feature bollards and vertical elements to protect people waiting.

Signalised Crossing

Signal phasing

The easiest and cheapest solution to reducing vehicle traffic and improving the ability for people to cross the street is to change the signal phasing at some key intersections around the Local Path. Reducing green time for turning movements into the street that includes the Local Path physically reduces the traffic capacity of these streets, while at the same time increasing green time for pedestrians crossing.

Signalised intersection

An effective, yet expensive option to reduce traffic speeds and volumes is to signalise intersections on the Local Path. While this is often not an appropriate treatment for a quiet residential street, it can be a good solution for a major arterial road. A signalised intersection can be implemented while at the same time restricting some movements. This is the most effective solution for busy roads, as it provides a safe crossing point, while at the same time reducing traffic speeds.

Cost ● ● ● ● ●

See page 125 - 133 for more information

Recommended Usage

- Recommended to be used in locations with high pedestrian crossing demands, high numbers of vehicles, and locations where motorists use secondary roads or residential side streets instead of the intended main roads ('cut-through traffic').
- This tool is compatible with public transport.

Design Considerations

- Consider the location of other signalised intersections as to make sure people do not see through one set of lights to the next.
- If lights are in close proximity to each other, phasing needs to be coordinated to reduce delay and ensure they don't negatively affect the surrounding transport network.
- It is recommended to include a pedestrian countdown timer.
- Consider school hours to ensure pupils have enough time to cross during the green phase.
- Different phasing regimes can be run during different hours of the day to minimise queueing.

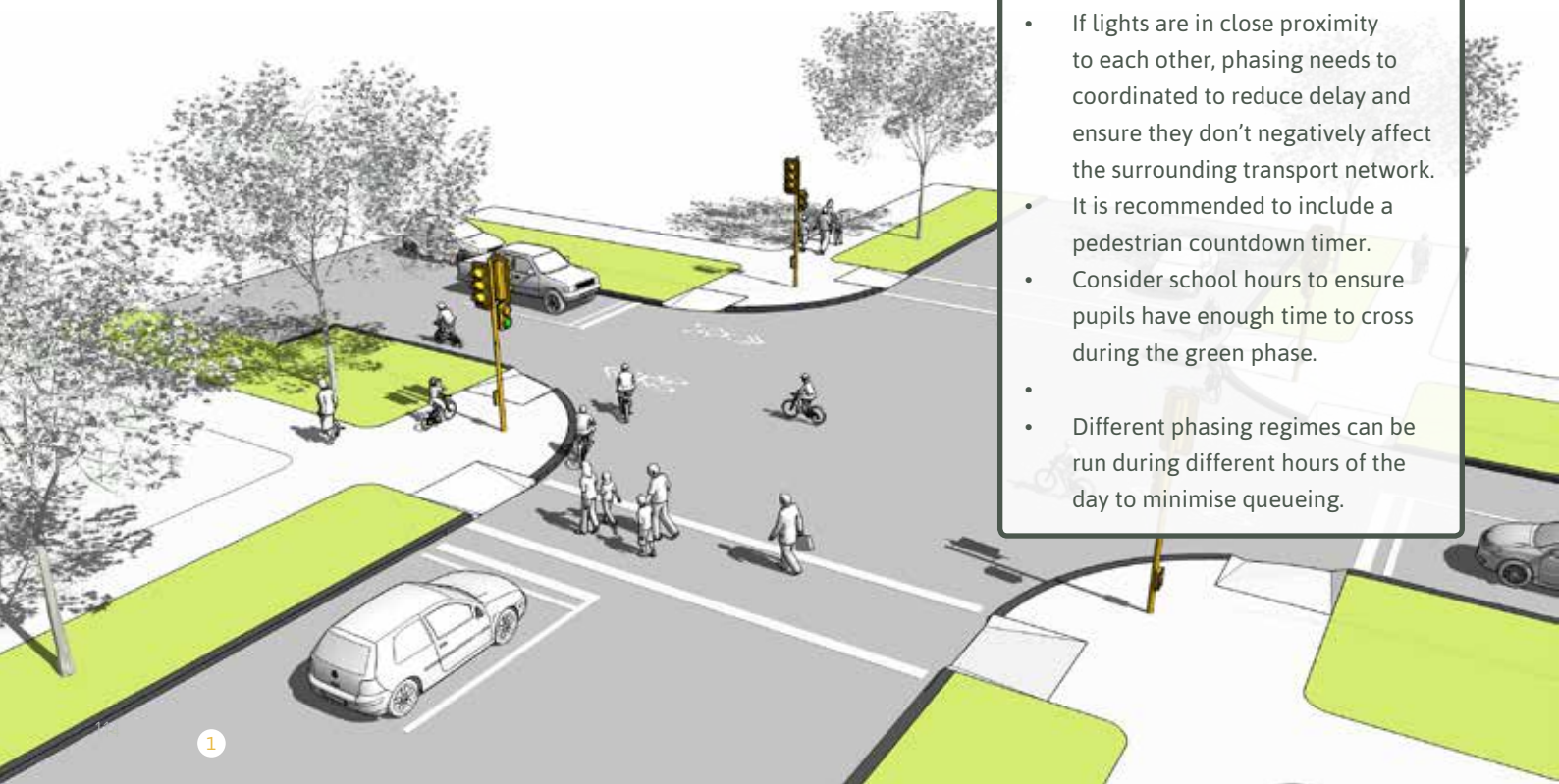

Typical

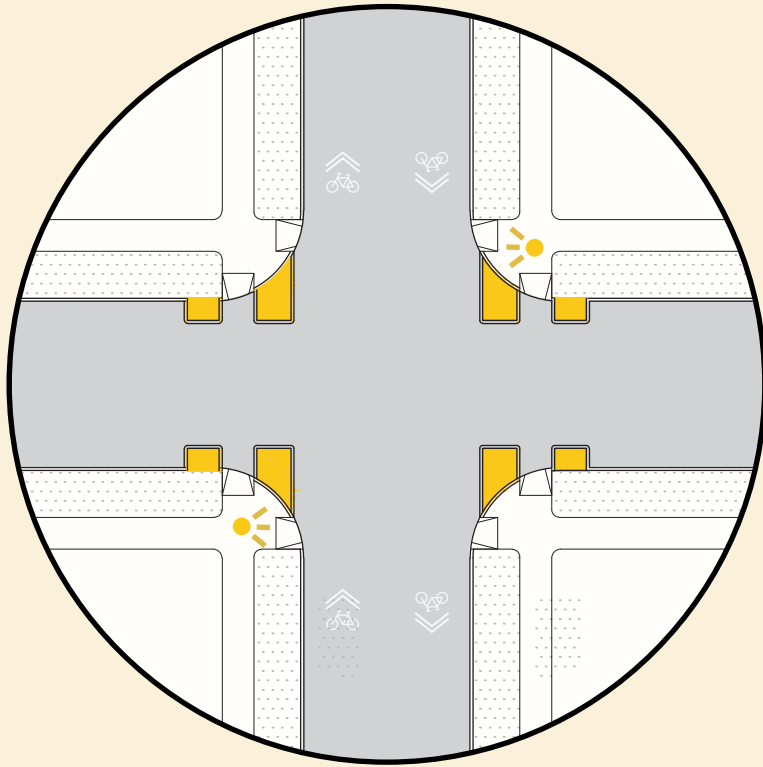

Variations

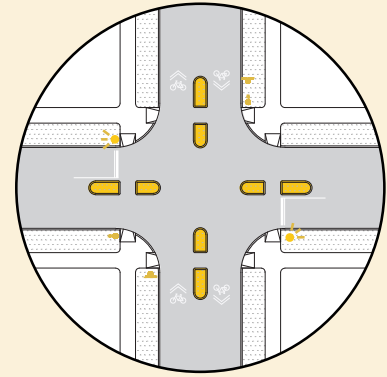

X-intersection_ Signalised crossings are commonly used at four-way intersections to enable easier crossing of streets for pedestrians and people on bikes. Phasing can be timed to enable a Barnes Dance / pedestrian scramble. This ensures prioritisation of pedestrians and people on bikes crossing.

Design Parameters

- 1 Advances warning to drivers.
- 2 Ensure traffic signals are spaced apart by at least 100m.

3.6

SIGNAGE & PATH MARKINGS

The segregation of users and the use of too many signs and markings can give the perception that there is low risk of an accident, which typically reduces the attentiveness of a person using a Local Path and their awareness of other users. This can create complacency and increase the likelihood of users having an accident with one another. Research and several international examples suggest that reducing the number and size of signs and markings has the counter-intuitive result of reducing accidents by heightening a user's sense of awareness of others. By using tools such as traffic calming and water sensitive design devices, streets can become self-explaining, where the users are encouraged to naturally adopt behaviour consistent with design and function of the street. By reducing or even removing signs and markings, users of a street or park tend to slow to the pace of the slowest mode, typically a pedestrian, which helps to facilitate the different users of the space, be it a pedestrian and a person on a bike or vehicle and a person on a bike, to interact with one another through eye contact so that they can determine between themselves who has right of way.

Signage and street / path markings are cost-effective yet highly-visible treatments that, when used sparingly, can improve the safety and experience on a Local Path network.

[Shared Path Markings](#)

[Street Markings](#)

[Wayfinding Signs](#)

[Change Priority Signage](#)

[Advanced Warning Signs](#)

Shared Path Markings

Shared path markings must be located at the beginning and end of all Local Paths, when a Local Path intersects with another path or street, and periodically along the shared path to remind users that the path is shared.

Cost ● ○ ○ ○ ○

See page 125 - 133 for more information

Design Parameters

- 1 The standard shared path marking consists of a cycle symbol and a slightly overlapping pedestrian symbol.
- 2 A chevron should generally be used to indicate the side of the transition the marking applies to. The exception to this is a large shared area where it is obvious which side of the transition the marking applies to, but the axis of travel is not clear, e.g. a shared area bordering the roadway.
- 3 Where the transition between the shared path and other uses is not clearly indicated by other elements such as a kerb or change in surfaces, a band can be used to help define this point.
- 4 Shared park markings with a single or double chevron can be placed along the length of a shared path to remind users of other potential users. There are two options for this application:
 - A pair of shared path symbols placed on one either side of the path with a single chevron indicating the direction of travel for that side of the path. These should be positioned on alternating sides 75 - 100m apart.
 - A larger double chevron shared path symbol placed in the centre of the path with chevrons either end.

Design Considerations

- Where a path crosses a side road, markings should be applied at each crossing point, i.e. as if the path terminates at the roadway.
- Colour: The luminance contrast between a marking and its background must be at least 70%, measured in accordance with section 5.3 of RTS 14 – Guidelines for facilities for blind and visually impaired pedestrians.
- Shared path markings are typically white, but this is not a requirement provided the above is achieved.
- A centre line and/or surface treatment which differentiates two sides of the path is required for sections of a shared paths narrower than 3m.



1_ Standard



2_ Single Chevron



3_ Band



4_ Double Chevron

Street Markings

The primary marking for Local Paths is the shared roadway marking, aka 'sharrow'. The sharrow is a bike symbol with a double chevron on top. The chevron can be rotated to the right or left side to indicate changes of direction, if turn sharrow markings are not used. Multiple chevrons can indicate crossing choices.

Cost ● ○ ○ ○ ○

See page 125 - 133 for more information

Design Considerations

- Remove centre lines to help heighten user awareness
- Centrelines can easily be removed when carriageways are resurfaced.
- Use side markings to make the street appear narrower.

Design Parameters

- Sharrow legends are placed 10 - 15m from major cross streets and spaced evenly along the length of the Local Path.
- Sharrows should be spaced approximately 30 - 40m apart and no more than 75m after that initial marking.
- In advance of a direction change or decision point along the neighbourhood Local Path, the last sharrow will use the directional chevron to inform people on bikes of the change of direction.



Standard Sharrow

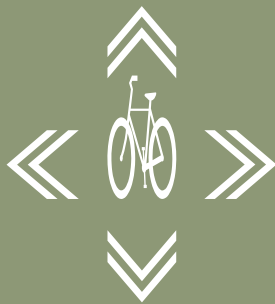

Sharrow Flower



Left Turning Sharrow



Right Turning Sharrow

Wayfinding Signs

Wayfinding signs are typically placed at key locations leading to and along Local Paths, including where multiple routes intersect and at key “decision points”. Wayfinding signs displaying destinations and distances can dispel common misconceptions about time and distance while increasing user ease and accessibility to the Local Paths network. Wayfinding signs also visually cue motorists that they are driving along a bicycle and walking route and should correspondingly use caution.

Design Considerations

- Provide people on bikes with direction, distance and/or estimated travel times to destinations including commercial districts, transit hubs, schools and universities, and other bike ways.
- Install in advance of turns at a distance great enough to allow a person on a bike to recognize, prepare for, and safely execute a turn.
- Be aware of “sign clutter” that can diminish the effectiveness of signage overall.

Cost ● ● ● ○ ○

See page 125 - 133 for more information

Opportunities for Placemaking

In many locations it may be appropriate to include artwork and other creative designs in the signage to enhance the route and special places along it.

Direction



For junctions and decision points use. To be placed about 10 meters before the major decision point or junction.

Marker



Where there are few infrastructure cues such as surface treatments to show you are still on the cycleway, the Marker sign provides an inexpensive way to 'breadcrumb' the route.

Link



To be used where the next section of a cycleway is unclear. The link sign is to provide a guide to the connection.

Fingerpost



For junctions and decision points use. To be placed at major junctions/decision points.

Route Marker



To provide high quality wayfinding at entrances to Local Paths.

Change Priority Signage

One way of prioritising a Local Path route over a side street is to ensure the side streets have stop signs at the intersections with the Local Path. This reduces the stop/start delay for bicycles while at the same time reducing intersection approach speed and allowing for eye contact between road users.

Stop signs on side streets require bicycles to stop for all traffic, which can be a nuisance for traffic on cross streets. In locations where high volumes of bicycles are expected to join a Local Path, a give way sign may be more appropriate. Stop/Give way signs orient to side streets while the street that features the Local Path has right of way.

Cost ●●●○○

See page 125 - 133 for more information

Design Considerations

- Special care needs to be taken at streets that serve a 'cut-through traffic' function, as prioritising the vehicle traffic will encourage its use. In these cases, additional traffic diversion measures might be required. A diagonal diverter is recommended as this is the most efficient way of removing a 'cut-through traffic' function.
- Speed management tools should also be implemented on the Local Path, as this street will have right of way and drivers will not be required to stop at intersections anymore.
- Stop signs are better at reducing vehicle speeds than give way signs, but its use depends largely on sight distances at the intersections.
- The Local Path should be highlighted on the through road using sharrows. This helps in explaining the change in priority to drivers.

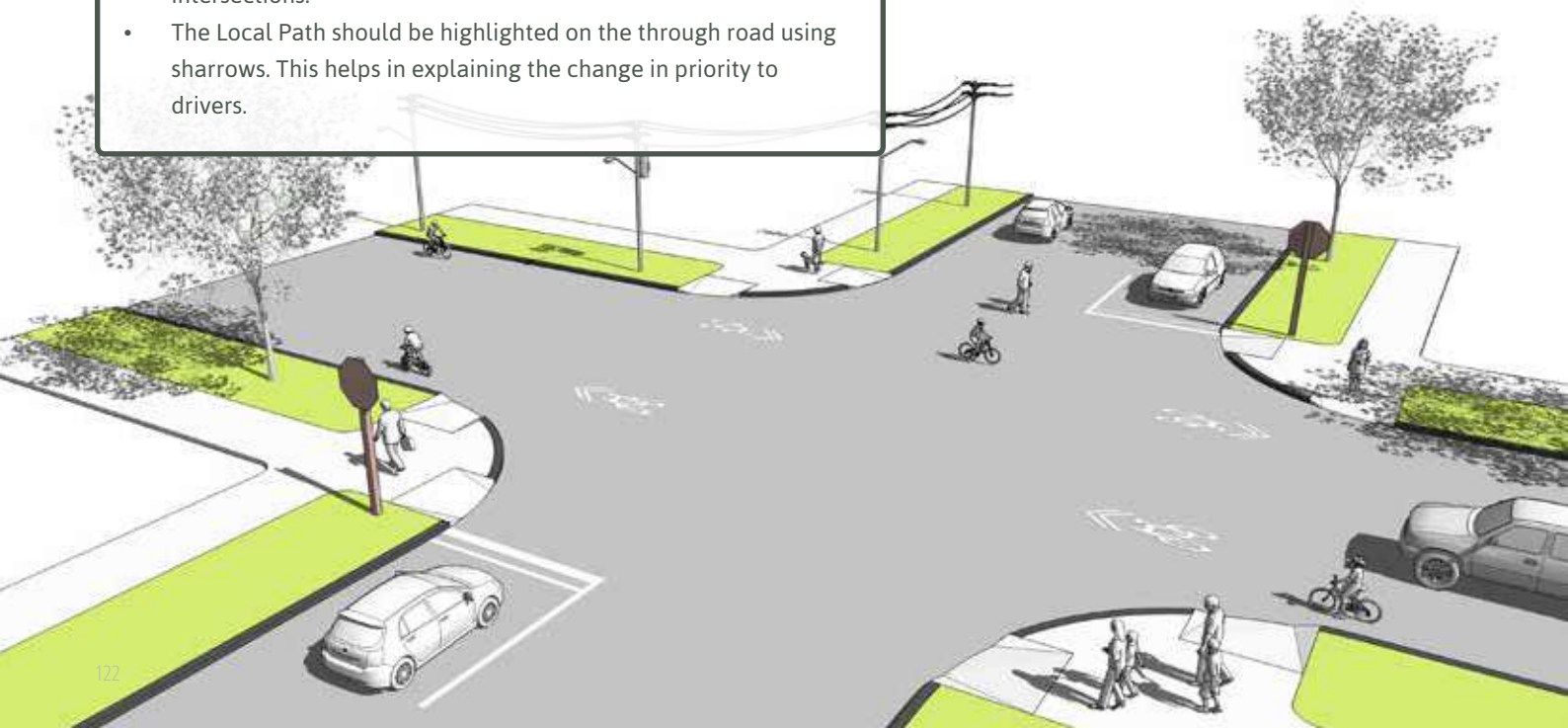

Advanced Warning Signs

Advanced warning signs are 'behavioural signs' to inform and alert people on bikes to expect pedestrians and other users on the Local Path. In order to maintain their effectiveness, advanced warning signs should be used sparingly. Examples of sites where advanced warning signs might be used include before a blind corner that precedes a junction or a steep downhill section.

Cost ● ● ● ○ ○

See page 125 - 133 for more information



PART FOUR

APPENDIX



4.0

COST GUIDE

This section provides guidance for the relative cost of implementing the various tools presented in this guide.

The purpose of the cost guide is not to enable users to calculate an indicative cost for the Local Path, but to compare the relative cost of one tool to another, so that for any given Local Path, a 'lower cost' and 'more expensive' design can be estimated.

There is a wide range of variables and variations that need to be taken into consideration for each of the tools presented in this guide; as such the prices presented here are indicative only and additional investigations will be needed.

The prices below provide indicative costs and guidance for the tools presented in the Local Paths Design Guide. The cost guide utilises a simple 'high - medium - low' comparison between tools of the same type. For example, the range of high - medium - low for path surfaces in parks is a cost comparison for surface options only, and is not comparing cost of paths against other tools such as lighting or water sensitive urban design.

The key for the indicative costs included throughout the guide is included below.

Indicative Costs: Examples

- ● ● ● ● High
- ● ● ● ● Ranges between medium - high
- ● ● ○ ○ Medium

Tools for Placemaking

Tools	Cost				Notes
	Low	Medium	High		
Te Aaranga Design Principles	●				Cost implications typically relate to additional time during design development
Tactical Urbanism		● ●			Cost can vary widely depending on design proposal - relatively untested in Auckland
Street Based Community Initiatives	●				Typically generated by community at little to no cost to council
Water Sensitive Urban Design					Cost savings can be made if integrated into existing infrastructure. Difficulty is very location dependent, ie when incorporated in greenfields design versus existing urban area retrofit
Rain Garden				●	
Carbon Filter		●			
Permeable Paving			●		
Vegetated Swale		●			
Street Trees					
Constructed Tree Pit				●	Maintenance in the long term is lower because you don't have root damage to utilities
In Ground		●			
Pollinator Pathways		●			If in road corridor, see road encroachment policy note under berm gardening
Berm Gardening	●				There is a policy on road encroachments that includes berm planting and there are restrictions on plant type, height and location

Tools for Parks

Tools	Cost				Notes
	Low	Medium	High		
Entry Exit Points					
Landscape Feature			●		
Taper		●			
Central Bollard	●				
Intersections					
Standard / Variation		●			
Island			●		
Impermeable Surfaces					<i>The length of the path will have an impact on cost comparisons with other surface options</i>
Exposed Aggregate			●		
Brushed Concrete		●			
Place Based Variation				●	
Up cycled Materials				●	
Permeable Surfaces					
Bound Aggregate	●				
Hoggin/Aggrok		●			
Permeable block pavers				●	
Rubber Matt			●		
Permeable Paver				●	
Bridges and Boardwalks: Structure					<i>Bridges require consent and may require engagement with specific stakeholder groups, particularly if relatively significant</i>
Galvanised				●	
Timber			●		
Bridges and Boardwalks: Surface					
Concrete Precast Panel				●	
Galvanised Steel			●		
Timber		●			

Tools	Cost				Notes
	Low	Medium	High		
Edge Treatments					
Timber (H3)	●				
Concrete			●		
Concrete (Place Based Variation)				●	
Galvanised			●		
Stainless				●	
Aluminium				●	
Balustrades					
Timber			●		
Steel				●	
Barriers					
Timber		●			
Steel			●		
Vegetated	●				Reduced initial cost. Consideration should be given to ongoing maintenance.
Fences					Difficulty will depend on how extensive the fencing is (visibility, design, height)
Timber			●		
Steel				●	
<i>Building consents may be required for balustrades Barriers, Fences. Balustrades, Barriers & Fences does not include retaining walls and structures.</i>					
Lighting					
Down lighting		●			
Up lighting			●		
Feature Lighting				●	
Internal Park Road Crossing					
Painted or Texture Finish		●			
Raised Crossing				●	

Tools to Reduce Traffic Volume

Tools	Cost				Notes
	Low	Medium	High		
Diagonal Diverter					
Typical				●	
Permeable	●				
Raised Median with Pedestrian and Bicycle Through Route					
Typical			●		
Skinny	●				
Mountable			●		
T- Intersection			●		
Kerb Extension					
Typical				●	
Mountable				●	
Planter Box	●				Cost will remain low if the kerb and utilities can be kept in place.
Vehicle Road Closure - Cul-de-sac					
Typical				●	Land will be required where street is not wide enough to accommodate vehicle turning circle.
Planter Boxes	●				Cost will remain low if the kerb and utilities can be kept in place.
Hammer Head				●	Land will be required where street is not wide enough to accommodate vehicle turning circle.

Tools to Reduce Traffic Speed

Tools	Cost					Notes
	Low		Medium		High	
Mini Roundabout						
Typical					●	
Painted	●					Variations that don't require retrofit of stormwater infrastructure are much more cost effective
Raised Table						
Typical				●		
Without Planter			●			
Speed Hump						
Typical	●					
With Cut Through	●					
Pinch Point						
Typical				●		
Planter Boxes	●					Variations that don't require retrofit of stormwater infrastructure are much more cost effective
One Lane Chicane				●		
Speed Cushion						
Typical				●		
Intersection					●	
Raised Platform						
Typical				●		
X - Intersection					●	
Offset Intersection					●	

Tools for Crossing the Street

Tools	Cost						Notes
	Low	Medium	High	Very High	Extremely High	Prohibitively High	
Offset Intersection Crossing							
Typical - Central Island						●	
Two Stage Turns			●				
Bidirectional cycleway on one side						●	
Zebra Crossing							
Typical	●						
Kerb Extension			●				
Raised zebra crossing				●			
Raised Crossing							
Typical				●			
Midblock Crossing				●			
Kerb Extension					●		
Kerb Build-outs							
Typical				●			
All Crossing Points					●		
Midblock				●			
Pedestrian Refuge							
Typical		●					
X-intersection			●				
With Zebra Crossing			●				
Courtesy Crossing							
Typical	●						
Intersection	●						
Signalised Crossing							
Typical - Mid-block					●		
Intersection					●		

Signage and Path Markings

Tools	Cost				Notes
	Low	Medium	High		
Shared Path Markings	●				
Wayfinding					
Direction		●			
Finger Post		●			
Link		●			
Route Marker			●		
Marker		●			
Street Markings					
Sharrows	●				
Remove Markings	●				
Advanced Warning Signs		●			
Change in Priority Signage		●			

